



Centrifugal fans

EBB-N Series

EBB-100



2
SPEED

The EBB-N extractor fans are suitable for many domestic and commercial ventilation applications where higher system resistance pressures are encountered. The range comprise of three models, EBB-100N, EBB-170N and EBB-250N, each available in different versions. The EBB-N models incorporate a forward curved centrifugal impeller with 2-speed single phase motor 230V50Hz, 4-pole (EBB-170N and 250N) or 2-pole motor (EBB-100N). IP44. Class II. Housing and impeller made in polypropylene. Suitable to operate with air temperature up to 40°C.

+ Attributes



Filters
Two metal filters (inox for models 170 and 250) that keep out dust and dirt in the exhaust.



Back draft shutter
The EBB-N are fitted with an automatic back draft shutter to prevent air entry and limit heat leakage when the extractor is not operating.



2 Back draft shutter
2 back draft shutter of Ø80 and Ø100 mm.



Forward curved centrifugal impeller
To deliver high performance with a minimum noise level against high static pressure system resistance.

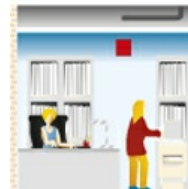

+ Installation

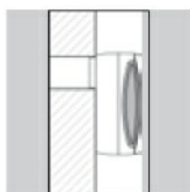

Surface

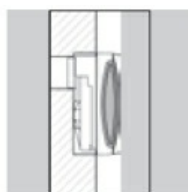

Built-in

+ Features

	S	T	HT
BACK DRAFT SHUTTER	EBB-170 N / EBB-250 N	EBB-170 N / EBB-250 N	EBB-170 N / EBB-250 N
2 BACK DRAFT SHUTTER	EBB-100 N	EBB-100 N	EBB-100 N
METAL FILTERS	EBB-100 N	EBB-100 N	EBB-100 N
INOX FILTERS	EBB-170 N / EBB-250 N	EBB-170 N / EBB-250 N	EBB-170 N / EBB-250 N
TWO SPEED	●	●	●
ADJUSTABLE RUN-ON-TIMER		●	●
INTERNAL HUMIDISTAT			●

+ Technical characteristics

Model	Speed (r.p.m.)		Abs. power at free discharge (W)	Voltage (V) 50Hz	Sound pressure level* (dB(A))	Airflow at free discharge (m³/h)	IP	Ø duct (mm)	Weight (Kg)
	VR	VL							
EBB-100 N	VR	1600	35	230	46	130	Class II / IP44	100/80	1,8
	VL	1050	15	230	34	75			
EBB-170 N	VR	1100	48	230	42	220	Class II / IP44	100	3
	VL	780	36	230	32	140			
EBB-250 N	VR	1225	51	230	46	270	Class II / IP44	100	3
	VL	900	36	230	38	190			

* At a distance of 1,5 m.

+ Dimensions

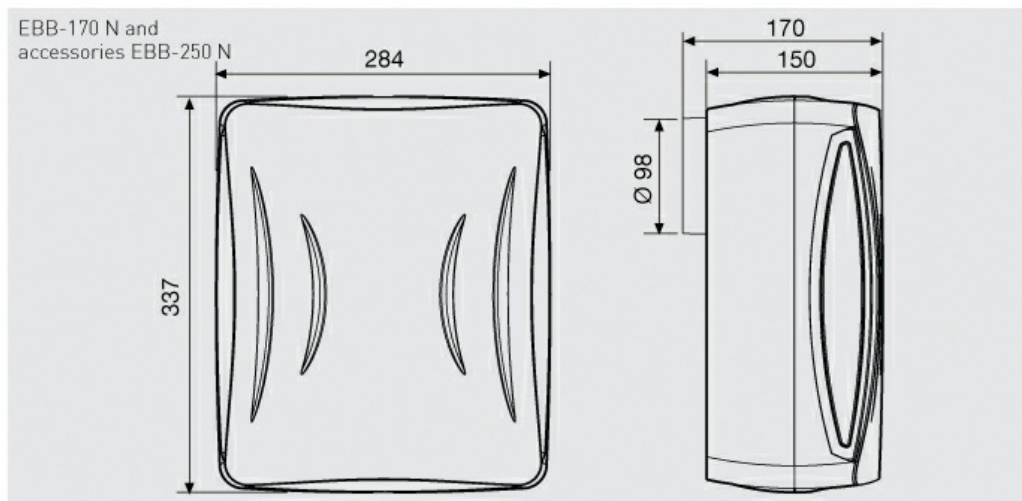
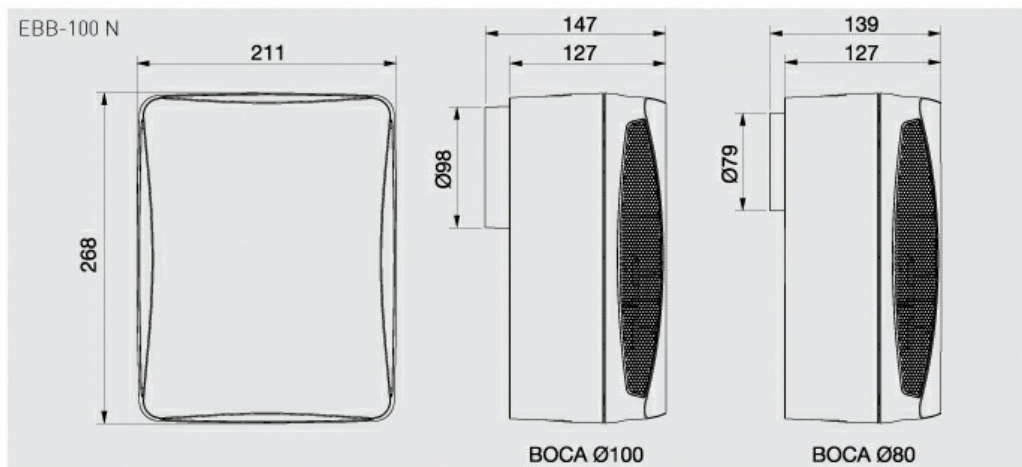

+ Curves

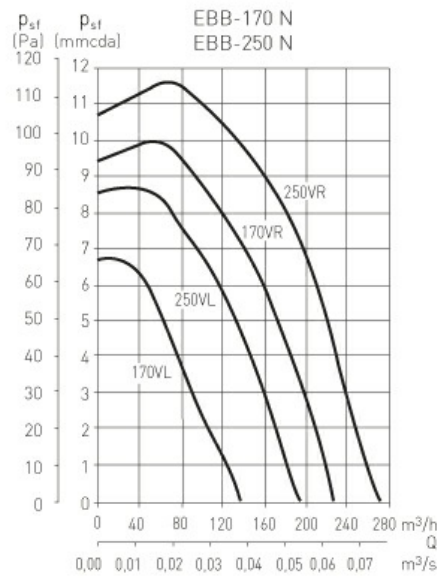
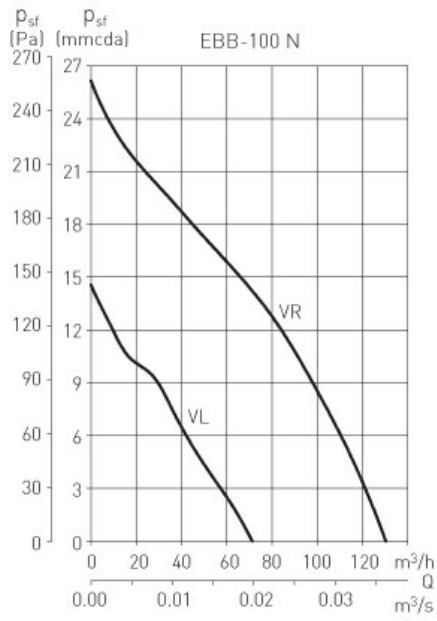

+ Mounting Accessories



GSA-100
Flexible aluminium
ducting.



GRA-75
Aluminium external
grille.



MRT-100
Circular duct
joining piece.



CX-80/125
Worm drive ducting
clip.



REB
Single phase
electronic
speed controllers.



REGUL-2
Two speed
switch.