



Cabinet fans manufactured from galvanised steel sheet with double thickness side panels lined with 25 mm thickness of fireproof fibreglass acoustic insulation (M0). Circular duct connection flange on the inlet. KABB / KAPT incorporates direct driven aluminium backward curved centrifugal impeller with motor fitted outside of the air stream. Supplied with galvanized drip tray and copper drain.

Motors

- KABB: Single-phase 4 pole motor 230V-50Hz, IP55, class F, with thermal protection, speed controllable by tension. Maximum temperature around the motor:
 KABB/4-3000/315: 70°C
 KABB/4-4000/355: 50°C
 KABB/4-6000/400: 40°C
- From KAPT/4-3000/315 to KAPT/4-9000/500: Three-phase 4 pole motor 230/400V-50Hz, IP55, Class F, with thermal protection, speed controllable by inverter.
- KAPT/4-12000/560: Three-phase 4 pole motor 400V-50Hz, IP55, Class F, with thermal protection, speed controllable by inverter.



Additional information

Working temperature from -20°C to 100°C.

Specific applications



Continuous



Industrial and commercial kitchens



Backward curved centrifugal impellers
 To prevent accumulation of dirtiness. Dynamically balanced.



Robustness
 Quality finished plastic corners and aluminium profile, providing a great robustness.



IP55 remote terminal box
 To ease installation and connection to external controls.

TECHNICAL CHARACTERISTICS

Before installation check that the product electrical characteristics listed on the data plate label (voltage, power, frequency, etc.) match those of the intended electrical supply.

Model	Speed (rpm)	Maximum absorbed power (W)	Maximum absorbed current (A)	Maximum air volume (m ³ /h)	Sound pressure level* (dB(A))			Weight (kg)	Variable frequency inverter	
					Inlet	Radiated	Outlet		Main supply	
									RMB	REV
KABB/4-3000/315	1370	304	1,6	2.460	50	45	52	14	RMB-3,5	REV-3
KABB/4-4000/355	1385	487	2,0	3.790	53	45	55	21	RMB-3,5	REV-3
KABB/4-6000/400	1375	1023	4,3	5.900	58	49	61	32	RMB-8	REV-5

* Sound pressure level measured in free field at 4m.

Model	Speed (rpm)	Maximum absorbed power (W)	Maximum absorbed current (A)		Maximum airflow (m ³ /h)	Sound pressure level* (dB(A))			Weight (kg)	Variable frequency inverter VFTM	
			230 V	400 V		Inlet	Radiated	Outlet		Main supply	
										1/230V/50Hz**	3/400V/50Hz
KABT/4-3000/315	1430	327	1,2	0,7	2.750	52	46	53	35	VFTM MONO 0,18	VFTM TRI 0,37
KABT/4-4000/355	1450	560	2,1	1,2	4.020	55	46	56	44	VFTM MONO 0,37	VFTM TRI 0,37
KABT/4-6000/400	1490	1430	6,1	3,5	6.300	60	51	63	59	VFTM MONO 1,1	VFTM TRI 1,5
KABT/4-9000/500	1430	2113	9,0	5,2	8.700	67	54	68	69	VFTM MONO 2,2	VFTM TRI 2,2
KABT/4-12000/560	1430	2530		6,2	11.400	63	52	66	98		VFTM TRI 3

* Sound pressure level measured in free field at 4m.

** Only 230/400V motor.

DIMENSIONS (mm)

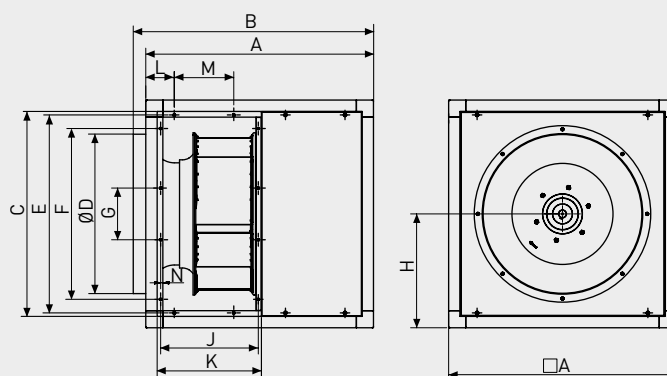

Model	A	B	C	D	E	F	G	H	J	K	L	M	N
KABB/4-3000/315	505	549	445	315	421	325	125	253	198	222	90	100	12
KABB/4-4000/355	550	592	490	355	466	370	170	275	222	245	60	100	12
KABB/4-6000/400	630	674	570	400	546	450	130	315	242	265	60	160	12
KABT/4-3000/315	505	549	445	315	421	325	125	253	198	222	90	100	12
KABT/4-4000/355	550	592	490	355	466	370	170	275	222	245	60	100	12
KABT/4-6000/400	630	674	570	400	546	450	130	315	242	265	60	160	12
KABT/4-9000/500	710	753	630	500	606	510	190	355	271	294	100	206	8
KABT/4-12000/560	800	844	720	560	696	600	182	400	343	366	100	209	8

PERFORMANCE CURVES

- q_v : Airflow in m^3/h and m^3/s .
- p_{sf} : Static pressure in Pa.
- LwA: Radiated sound power level in dB(A), fan ducted.
- Dry air at 20°C and 760 mmHg.
- Performance data in accordance with ISO 5801 and AMCA 210-99 Standards.

Sound power spectrum: The sound levels shown in these tables are sound power levels at the discharge, radiated and inlet, in dB(A) for frequency ranges at 3 points of the curve: (a) free discharge, (b) medium pressure, (c) maximum pressure.

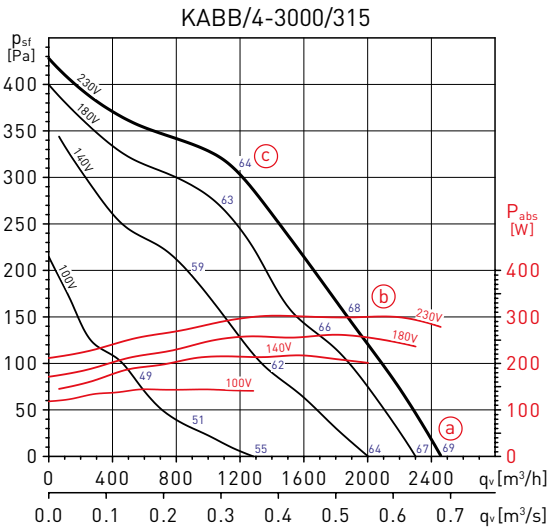

230V - 50Hz		63	125	250	500	1000	2000	4000	8000	LwA
a	Radiated	39	68	53	54	55	51	50	46	69
	Inlet	46	70	66	67	66	66	61	57	75
	Outlet	46	70	68	70	70	69	63	58	77
b	Radiated	38	67	53	53	54	49	47	41	68
	Inlet	45	69	66	66	65	64	58	52	73
	Outlet	46	68	67	70	68	64	59	52	75
c	Radiated	40	63	52	53	54	48	46	42	64
	Inlet	47	65	65	66	65	63	57	53	72
	Outlet	48	67	67	69	67	63	57	51	74

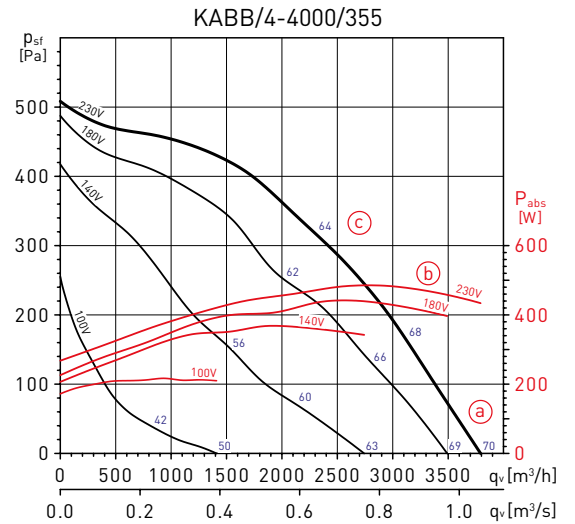

230V - 50Hz		63	125	250	500	1000	2000	4000	8000	LwA
a	Radiated	44	68	58	58	63	59	57	56	70
	Inlet	47	75	68	69	71	69	65	64	78
	Outlet	48	78	70	73	73	72	68	65	81
b	Radiated	40	65	57	57	62	57	55	52	68
	Inlet	43	72	67	68	70	67	63	60	76
	Outlet	44	74	68	71	71	69	64	59	78
c	Radiated	40	59	55	55	60	55	52	48	64
	Inlet	43	66	65	66	68	65	60	56	73
	Outlet	44	73	68	69	69	66	61	56	77

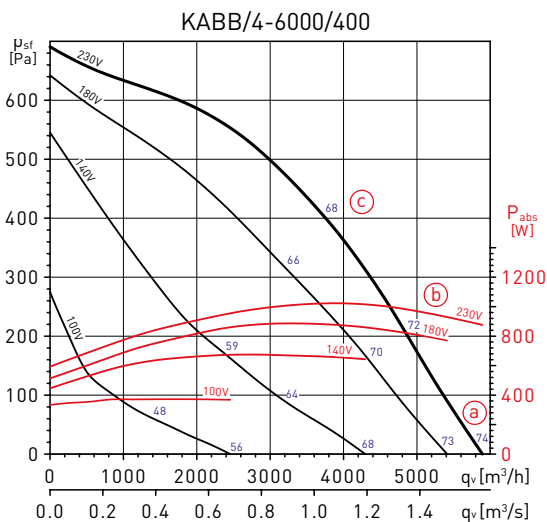

230V - 50Hz		63	125	250	500	1000	2000	4000	8000	LwA
a	Radiated	49	73	62	62	61	60	58	50	74
	Inlet	55	80	74	74	74	74	72	65	84
	Outlet	52	84	75	79	78	75	75	64	87
b	Radiated	45	71	60	61	60	58	53	46	72
	Inlet	51	78	72	73	73	72	67	61	81
	Outlet	50	81	72	76	75	73	69	61	84
c	Radiated	43	66	60	59	59	57	52	45	68
	Inlet	49	73	72	71	72	71	66	60	79
	Outlet	49	79	72	75	73	71	66	59	82

PERFORMANCE CURVES

- q_v : Airflow in m^3/h and m^3/s .
- p_{sf} : Static pressure in Pa.
- LwA: Radiated sound power level in dB(A), fan ducted.
- Dry air at 20°C and 760 mmHg.
- Performance data in accordance with ISO 5801 and AMCA 210-99 Standards.

Sound power spectrum: The sound levels shown in these tables are sound power levels at the discharge, radiated and inlet, in dB(A) for frequency ranges at 3 points of the curve: (a) free discharge, (b) medium pressure, (c) maximum pressure.

KABT/4-3000/315

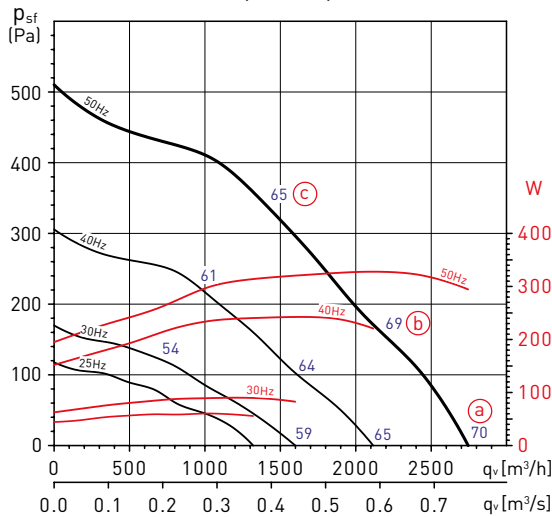

KABT/4-3000/315		63	125	250	500	1000	2000	4000	8000	LwA
	Radiated	40	69	54	55	56	52	51	47	70
a	Inlet	47	71	67	68	67	67	62	58	76
	Outlet	47	71	69	71	71	70	64	59	78
	Radiated	39	68	54	54	55	50	48	42	69
b	Inlet	46	70	67	67	66	65	59	53	75
	Outlet	47	69	68	71	69	65	60	53	76
	Radiated	41	64	53	54	55	49	47	43	65
c	Inlet	48	66	66	67	66	64	58	54	73
	Outlet	49	68	68	70	68	64	58	52	75

KABT/4-4000/355

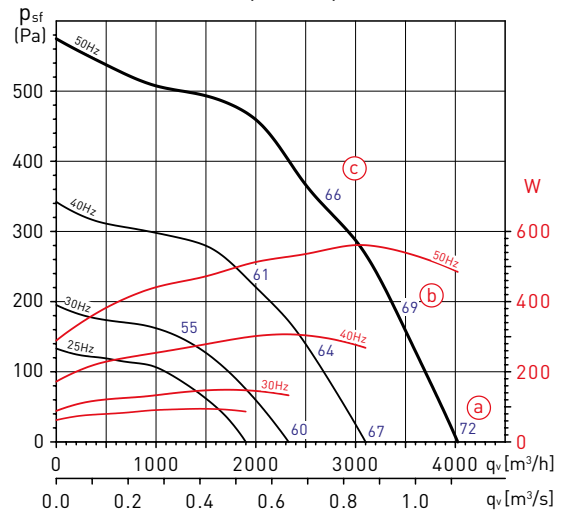

KABT/4-4000/355		63	125	250	500	1000	2000	4000	8000	LwA
	Radiated	45	69	59	59	64	60	58	57	72
a	Inlet	48	76	69	70	72	70	66	65	80
	Outlet	49	79	71	74	74	73	69	66	82
	Radiated	41	66	58	58	63	58	56	53	69
b	Inlet	44	73	68	69	71	68	64	61	78
	Outlet	45	75	69	72	72	70	65	60	79
	Radiated	41	60	56	56	61	56	53	49	66
c	Inlet	44	67	66	67	69	66	61	57	74
	Outlet	45	74	69	70	70	67	62	57	78

KABT/4-6000/400

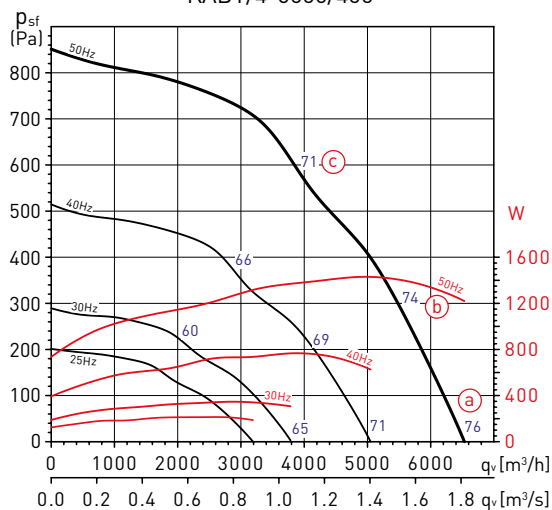

KABT/4-6000/400		63	125	250	500	1000	2000	4000	8000	LwA
	Radiated	51	75	64	64	63	62	60	52	76
a	Inlet	57	82	76	76	76	76	74	67	85
	Outlet	54	86	77	81	80	77	77	66	89
	Radiated	47	73	62	63	62	60	55	48	74
b	Inlet	53	80	74	75	75	74	69	63	83
	Outlet	52	83	74	78	77	75	71	63	86
	Radiated	45	68	62	61	61	59	54	47	71
c	Inlet	51	75	74	73	74	73	68	62	81
	Outlet	51	81	74	77	75	73	68	61	84

KABT/4-9000/500

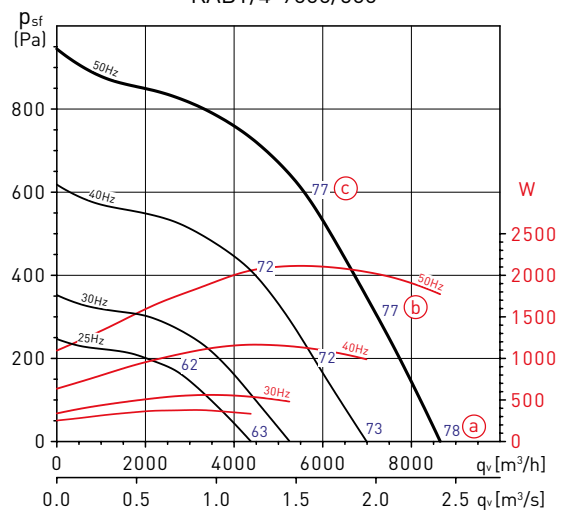

KABT/4-9000/500		63	125	250	500	1000	2000	4000	8000	LwA
	Radiated	53	76	67	64	71	66	64	61	78
a	Inlet	56	86	81	81	87	85	81	82	92
	Outlet	56	89	82	84	91	88	81	78	95
	Radiated	51	75	66	63	66	62	63	59	77
b	Inlet	54	85	80	80	82	81	80	80	90
	Outlet	54	87	80	82	84	82	79	76	91
	Radiated	52	75	69	62	65	61	62	56	77
c	Inlet	55	85	83	79	81	80	79	77	90
	Outlet	55	87	80	81	81	79	77	73	90

PERFORMANCE CURVES

- q_v : Airflow in m^3/h and m^3/s .
- p_{sf} : Static pressure in Pa.
- LwA: Radiated sound power level in dB(A), fan ducted.
- Dry air at 20°C and 760 mmHg.
- Performance data in accordance with ISO 5801 and AMCA 210-99 Standards.

Sound power spectrum: The sound levels shown in these tables are sound power levels at the discharge, radiated and inlet, in dB(A) for frequency ranges at 3 points of the curve: (a) free discharge, (b) medium pressure, (c) maximum pressure.

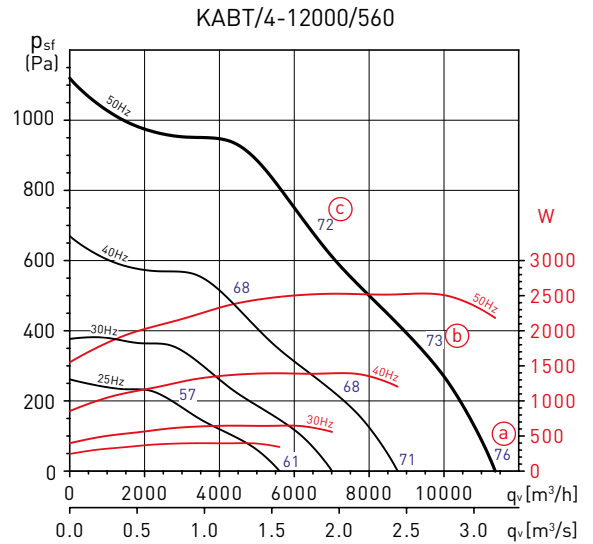

KABB/4-12000/560	63	125	250	500	1000	2000	4000	8000	LwA
Radiated	56	70	68	65	68	67	67	59	76
a Inlet	60	78	81	80	81	82	81	72	89
Outlet	60	85	83	84	85	84	83	73	92
Radiated	55	68	66	64	66	64	60	53	73
b Inlet	59	76	79	79	79	79	74	66	86
Outlet	59	82	80	83	83	81	77	69	89
Radiated	54	68	66	63	65	61	57	54	72
c Inlet	58	76	79	78	78	76	71	67	85
Outlet	60	78	80	82	81	78	73	68	87

MOUNTING ACCESSORIES



FD KABT
Circular coupling flange
To fit to the outlet.

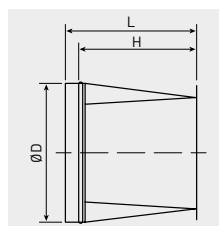

Model	Ø D	L	H
USD-3000	315	450	400
USD-4000	355	450	400
USD-6000	400	450	400
USD-9000	500	450	400
USD-12000	560	450	400



CTI KABT
Outdoor cover
For outdoor installations.

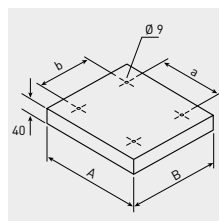

Model	A	B	a	b
CTI KABB-3000	535	535	325,2	420,7
CTI KABB-4000	580	580	370	465,5
CTI KABB-6000	660	660	450	545,5
CTI KABB-9000	740	740	510	605,5
CTI KABB-12000	830	830	600	695,5

MOUNTING ACCESSORIES



ACOP RECT KABT
Rectangular elastic coupling

To fit to the outlet.
 Avoids transmission of vibrations.

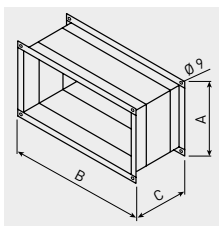

Model	A	B	C
ACOP RECT KABT-3000	220	443	143
ACOP RECT KABT-4000	243	488	143
ACOP RECT KABT-6000	264	568	143
ACOP RECT KABT-9000	292	628	143
ACOP RECT KABT-12000	364	718	143



KSE
Vibration damping supports

Rubber vibration damping supports that reduce vibrations and attenuate the noise of the installation.
 (1 KSE = 4 supports in a bag).



ACOPEL F400 N
 Circular flexible connector.
 Certified F400-120.

Model	Flexible connector
KABB-KABT/4-3000/315	ACOPEL F400-315/160N
KABB-KABT/4-4000/355	ACOPEL F400-355/160N
KABB-KABT/4-6000/400	ACOPEL F400-400/160N
KABT/4-9000/500	ACOPEL F400-500/160N
KABT/4-12000/560	ACOPEL F400-500/160N

ELECTRICAL ACCESSORIES



VFTM
 Adjustable frequency drives.



RMB
 Single-phase speed controller by auto-transformer
 IP65.



REV
 Single-phase speed controller by auto-transformer
 IP44
 Terminals for motor thermal protection (PTO).