

**SECURE, SUSTAINABLE AND
STYLISH NEXT GENERATION
ALUMINIUM ROOF LANTERN**



Product Catalogue

07/2023





SCAN ME

Product Features Video

- Patented† Sheerline corner joint provides structural integrity and reduces misaligned corners
- Intelligent system design creates an ultra secure lantern for added peace of mind
- Unique Thermlock® technology gives class leading thermal performance
- Low line glazing and inline rafter cappings create the ultimate contemporary look
- Manufactured in-house in the UK, for a robust and agile supply chain you can rely on

3
stocked
colours

9
dual colour
combinations

Bespoke colours also available

See page 11 for the full colour range



secure | sustainable | stylish



The S1 system combines security, thermal performance and refined looks to create the ultimate next generation aluminium lantern roof



Designed, made and delivered by Sheerline

Manufactured in the UK, we design and make every major aluminium and moulded component ourselves for a resilient and reliable supply chain. This gives us the control to offer unbeatable and responsive service, helping keep lead-times agile and responsive.



The UK's most secure lantern roof

Anti-tamper screws, enclosed anti-tamper glazing, security tape and a patent pending glass lock, alongside S1's high security ridge end, combine to make Sheerline's S1 system the UK's most secure non bonded aluminium lantern roof.

†Patent registration number: GB2569209 *Mainstream residential roof lantern.

Secured by Design



Official Police Security Initiative

UPGRADE OPTION
NOW AVAILABLE

The **SBD upgrade** uses security clamping plates to lock laminated glass in place, preventing lifting and removal by would-be intruders[†] even if rafter top caps have been removed. These stainless steel components are held firmly in place by security screws for added strength.



At a glance

- 25° pitch
- 13 styles
- 50mm sightlines
Rafter, hip, jack rafters and ridge
- Max 3.2 x 6m
- SBD option
- 1.2KN/m² snowload
Covering the whole of the UK up to 200m altitude.

The S1 roof lantern delivers real benefits to homeowners in a system that is as installer friendly as the rest of the Sheerline range.

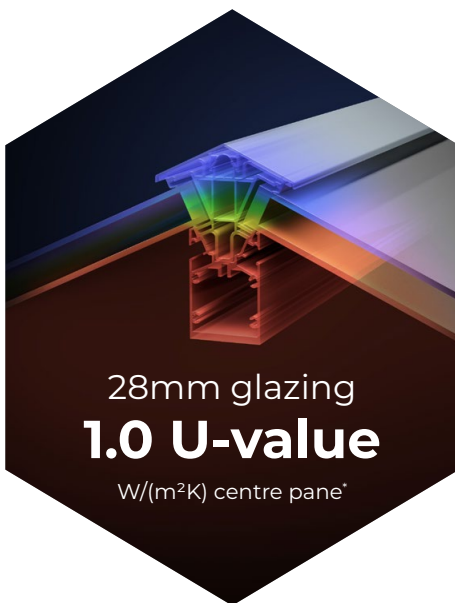

28mm glazing
1.0 U-value

W/(m²K) centre pane*

Thermlock® technology

Our next generation lantern provides exceptional thermal performance using 28mm glazing combined with Thermlock® closed-cell, insulating chambers to create class leading thermal performance, far superior to traditional polyamide thermal breaks.

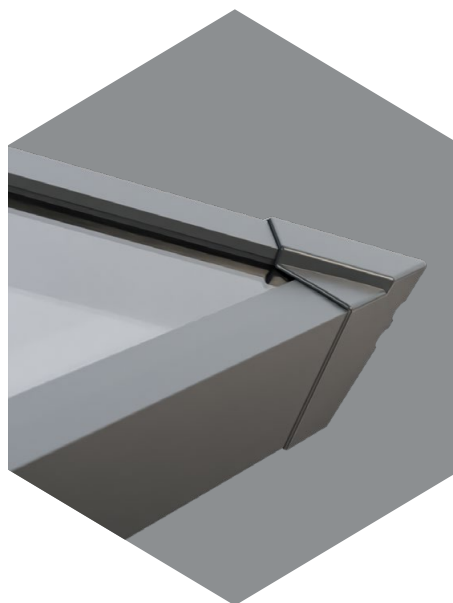

Slim, ultra low line aesthetics

Careful attention has been given to style with rafter and hip top caps sitting just 8mm above the exterior glazing level. While corner and rafter end caps run perfectly in line with the perimeter of the lantern, creating a sleek and refined architectural appearance.

THERMLOCKI[®]

technology inside

Thermal performance

Thermlock[®] multi-chamber technology used in the eaves beam, ridge and all rafter and hip bars creates an exceptionally thermally insulated lantern. With a unique co-extruded perimeter seal ensuring draughts and rain are kept safely outside, while 28mm glazing allows acoustic dampening glass to be fitted if required.

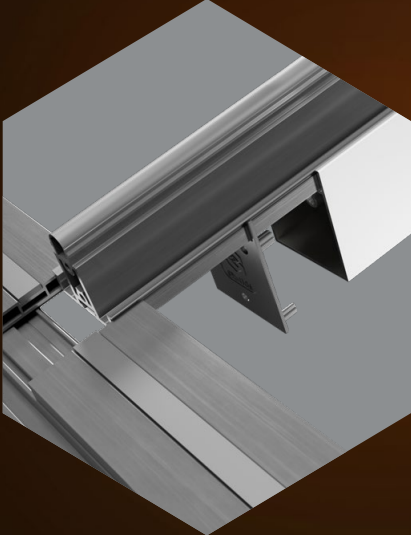

Our eaves beam design also ensures aluminium sections remain internal, preventing cold bridging and condensation issues.

Installer friendly



Unique hook brackets support the hip rafters during construction, simplifying fitting on site and speeding up installation. We've also designed out many common issues installers encounter and include internal rafter end caps to prevent bars marking the eaves beam during installation.



Style options

Sheerline aluminium roof lanterns are available in a choice of 13 styles from square 'pyramid' designs to grander options suitable for larger 'orangery' style installations.

Maximum sizes range from 3.2m wide to an impressive 6m long, all set at a 25° pitch and all weather rated for the whole of the UK*.

S1 lanterns also feature an integral LED light channel in the eaves beam – giving an easy way to add lighting to an installation if required.

**Rated for a snow load of 1.2 kN/m².
Covering the whole of the UK up to 200m altitude.*



3 way option

Our new 3 Way option allows for bigger spans to be catered for without the need for jack rafters.

All with the same sleek aesthetics as our existing 2 and 4 way designs.



Now available with

SHEERVENT[®] **FLUSH INTELLIGENT VENTILATION**

With a sleek minimalist design that sits perfectly flush with S1's rafter bars, and using powered actuators that can be intelligently automated, Sheerline has reimagined roof vents, bringing them into the 21st century at last.

Next generation lantern

Secure, sustainable and stylish

Deep internal roof bars, clean lines and discrete external aesthetics create an exceptional looking roof. Innovative design and patented technology ensure it's also the most secure and thermally efficient.





Aluminium Profiles

Item	Code	Description	Finish options	Pack Qty
	SRA100	Eaves Beam	Pure White, Jet Black, Anthracite Grey - stocked Bespoke - to order	1x6m
	SRA101	Glass Closure Trim	Pure White, Jet Black, Anthracite Grey - stocked Bespoke - to order	1x6m
	SRA200	Ridge Bar	Pure White, Jet Black, Anthracite Grey - stocked Bespoke - to order	1x6m
	SRA202	Ridge Top Cap	Pure White, Jet Black, Anthracite Grey - stocked Bespoke - to order	1x6m
	SRA300	Rafter Bar	Pure White, Jet Black, Anthracite Grey - stocked Bespoke - to order	1x6m
	SRA302	Rafter Top Cap	Pure White, Jet Black, Anthracite Grey - stocked Bespoke - to order	1x6m
	SRA303	Jack Rafter Bar	Pure White, Jet Black, Anthracite Grey - stocked Bespoke - to order	1x6m
	SRA304	Centre Rafter Bar	Pure White, Jet Black, Anthracite Grey - stocked Bespoke - to order	1x6m
	SRA310	Hip Bar	Pure White, Jet Black, Anthracite Grey - stocked Bespoke - to order	1x6m
	SRA312	Hip Rafter Top Cap	Pure White, Jet Black, Anthracite Grey - stocked Bespoke - to order	1x6m

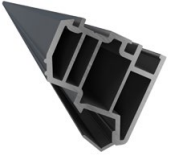

Thermlock® Profiles

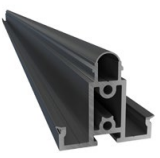
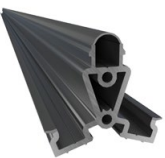
Item	Code	Description	Material	Pack Qty
	SRP102	Eaves Beam Body	Thermlock with co-extruded gasket	4 x 6.1 Mtrs
	SRP103	Infill Glazing Trim	Thermlock with co-extruded gasket	4 x 6 Mtrs
	SRP201	Ridge Body	Thermlock with co-extruded gasket	4 x 6 Mtrs
	SRP301	Rafter Body	Thermlock with co-extruded gasket	4 x 6 Mtrs
	SRP311	Hip Body	Thermlock with co-extruded gasket	4 x 6 Mtrs



Zinc Castings

Item	Code	Description	Finish options	Pack Qty
	SRH100	2 Way Crown Top Cap	Pure White, Jet Black, Anthracite Grey - stocked Bespoke - to order	10
	SRH101	4 Way Crown Top Cap	Pure White, Jet Black, Anthracite Grey - stocked Bespoke - to order	10
	SRH102	External Rafter End Cap	Pure White, Jet Black, Anthracite Grey - stocked Bespoke - to order	10
	SRH103	External Hip End Cap	Pure White, Jet Black, Anthracite Grey - stocked Bespoke - to order	10
	SRH104	3 Way Crown Top Cap	Pure White, Jet Black, Anthracite Grey - stocked Bespoke - to order	10

Injection Mouldings

Item	Code	Description	Finish options	Pack Qty
	SRM100	2 Way Crown Moulding	Pure White, Jet Black, Anthracite Grey - stocked Bespoke - to order	10
	SRM101	4 Way Crown Moulding	Pure White, Jet Black, Anthracite Grey - stocked Bespoke - to order	10
	SRM102	Screw Cover Cap	Pure White, Jet Black, Anthracite Grey - stocked Bespoke - to order	20
	SRM103	Eaves Beam Connector	–	20
	SRM104	Jack Rafter Connector	–	10 Pairs
	SRM105	Rafter to Ridge Connector	–	20
	SRM106	Internal Rafter End Cap	–	20
	SRM107	Internal Hip End Cap	–	20
	SRM108	Hip Hook Bracket	–	20
	SRM109	3 Way Crown Moulding	Pure White, Jet Black, Anthracite Grey - stocked Bespoke - to order	10

Corner Fixings

Item	Code	Description	Pack Qty
	SM113	Prestige Corner Cleat Assembly	100
	SH119	Cleat Repair Screw	100

Gaskets

Item	Code	Description	Pack Qty
	SG802	Bubble Gasket	200 Mtrs
	SRH121	Glazing Trim Tape	50 Mtrs
	SRH122	2 Way Crown Top Cap Seal	10
	SRH123	4 Way Crown Top Cap Seal	10
	SRH131	3 Way Crown Top Cap Seal	10

Packing/Protective Tapes

Code	Description	Pack Qty
PT015	15mm Sheerline Protective Tape	250m Roll
PT030	30mm Sheerline Protective Tape	500m Roll
PT040	40mm Sheerline Protective Tape	500m Roll
PT060	60mm Sheerline Protective Tape	500m Roll
PT080	80mm Sheerline Protective Tape	500m Roll
PT120	120mm Sheerline Protective Tape	500m Roll
ST001	24mm Sheerline Packaging Tape	66m Roll
ST002	48mm Sheerline Packaging Tape	66m Roll

Ancillaries and Fixings

Item	Code	Description	Pack Qty
	SH113	90° Door Sash External Chevron	200
	SH958	Hip Drill Jig	1
	SH959	Rafter Drill Jig	1
	SH960	SI SBD Drill Jig	1
	SRH110	M8 x 110mm Cap Head	100
	SRH111	4.8 x 32mm Shallow Pan Head	1000
	SRH112	4.8 x 50 Shallow Pan Head	1000
	SRH113	5.5 x 75mm Shallow Pan Head	200
	SRH114	M8 x 50mm Coach Screw	100
	SRH115	4.8 X 32mm Shallow Pan Head - Security Screw	1000
	SRH116	4.8 x 25mm Countersunk	1000
	SRH117	4.8 x 80mm Shallow Self Drill	200
	SRH118	TX20 Security Screw Bit	1

Technical information, specifications, literature and other materials are provided for illustration only, and may show and refer to product options. The accuracy of such information is not guaranteed and is subject to change without notification. The evaluation and selection of products and determining whether products are suitable for their intended use should be discussed between the end user and the installer/fabricator, as this falls outside our remit as system component manufacturer.

Item	Code	Description	Pack Qty
	SRH124	M8 Washer	200
	SRH125	Lantern Ancillary Box	10
	SRH126	Outer Sleeve Installation Guide	10
	SRH128	Rafter Clamping Plate (inc screws)	8
	SRH129	Hip Rafter Clamping Plate (inc screws)	8
	SRH130	4.8 X 50mm Shallow Pan Head - Security Screw	1000



STANDARD LANTERN COLOURS
All available in dual colour combinations.



Pure White
9010
Matt



Anthracite Grey
7016
Matt



Jet Black
9005
Matt

BESPOKE LANTERN COLOUR EXAMPLES

Please contact us for your requirements to discuss minimum order volumes. All available in dual colour combinations.

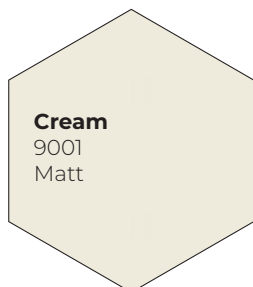

Cream
9001
Matt



Agate Grey
7038
Matt



Squirrel Grey
7000
Matt

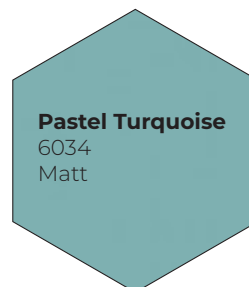

Pastel Turquoise
6034
Matt



Chocolate Brown
8017
Matt



Hipca Gloss White
9910 Gloss



Or most RAL colours
Available in Matt, Satin or Gloss finishes

DISCLAIMER

Due to the variability of manufacturing processes and the differences in the methods used to represent these colours, we cannot guarantee an exact colour match between the actual paint colour and the colour as seen on-screen or when printed. The RAL colour references are also provided as a guide only and we recommend asking to see a physical sample prior to order if required. All colours and finishes are supplied within standard tolerance ranges.



Manufactured and designed in the UK, innovative aluminium windows and doors with a unique approach to integrated systems design.

www.sheerline.com

☎ 01332 978000 | ✉ info@sheerline.com

