

Wir halten dicht.

Das innovative Fensterbankdichtsystem für
WDVS, Holzbau und Mauerwerk.



emv SYSTEM: **Fensterbanksystem**



emv AG ▪ Gewerübergreifende Systemlösungen ▪ made in Germany



emv-VARIO - Fensterbankkeile „wasserdicht“ - PVC oder ALU-Slider

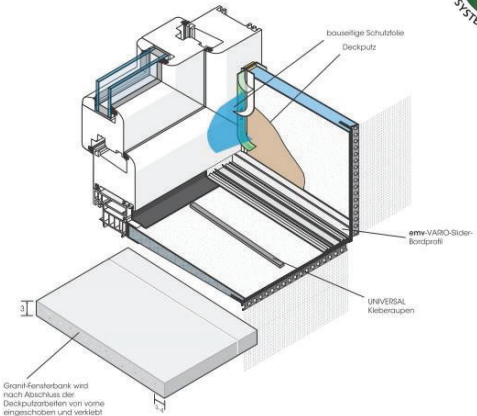
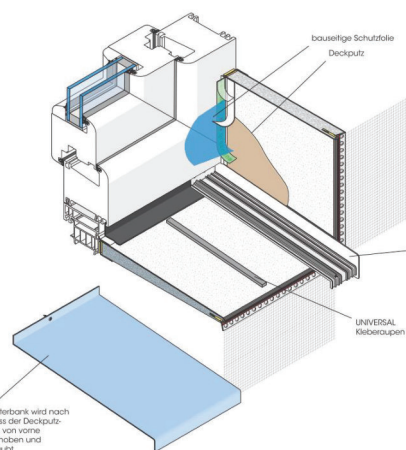
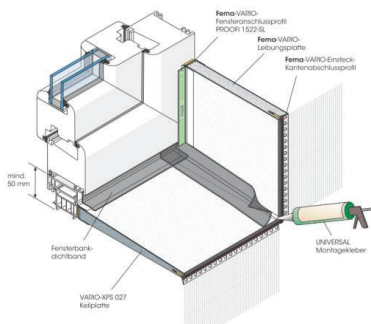

- Montage der Fensterbank nach der Fassadenarmierung.
- zweite Entwässerungsebene nach den Empfehlungen der Gütegemeinschaft Wärmedämmung und Fassade e.V.

- kein abkleben der Fensterbank während der Verputzarbeiten.
- Längenänderung innerhalb des Systems
- schnelle Montage der Bank da keine Haltewinkel mehr notwendig sind.



emv AG ▪ Gewerkübergreifende Systemlösungen ▪ made in Germany

emv-VARIO - Fensterbankkeile „wasserdicht“ - PVC oder ALU-Slider

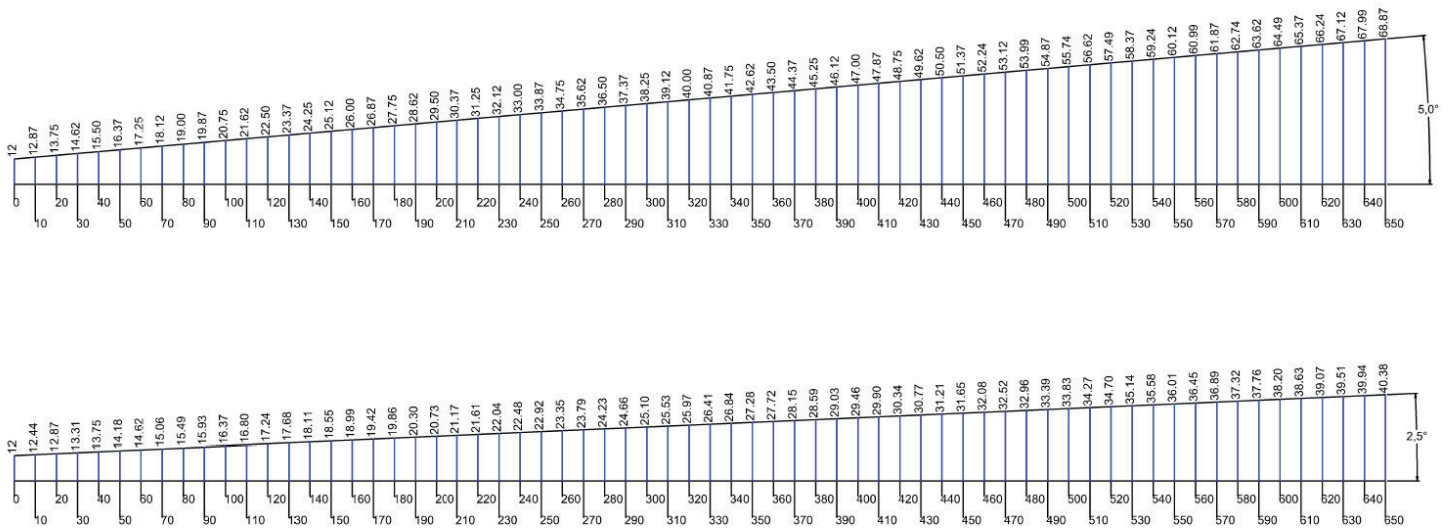

emv-VARIO - FENSTERBANKSYSTEME



V-1: emv-SlidePro ALU passend für SlidePro Alufensterbänke



V-2: emv-PVC Slider ALU 25mm passend für alle Alufensterbänke (Slider L)

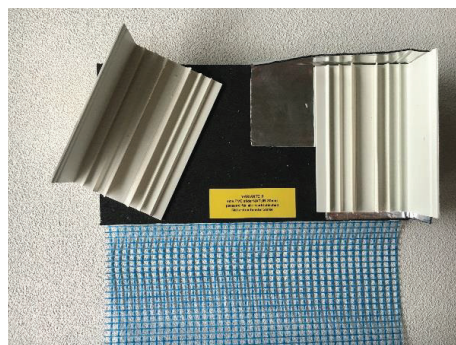

V-3: emv-PVC Slider NATUR 30mm passend für alle Natursteinbänke (Slider L)



V-4: emv-PVC Slider DESIGN 15mm passend für HELOPAL 15mm (Slider U)

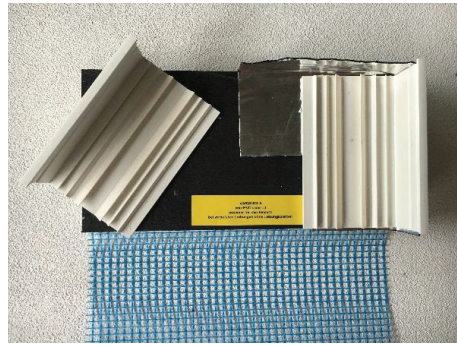

V-5: emv-PVC Slider U passend für den Einsatz bei verputzten Leibungen ohne Leibungsplatten (Slider U)



Slider L



Slider U



emv AG ▪ Gewerübergreifende Systemlösungen ▪ made in Germany

V-1: emv-SlidePro ALU passend für emv-SlidePro Alufensterbänke



V-1: emv-SlidePro ALU passend für SlidePro Alufensterbänke





emv AG ▪ Gewerübergreifende Systemlösungen ▪ made in Germany

V-2: emv-PVC Slider ALU 25mm passend für alle marktüblichen Alufensterbänke (Slider L)

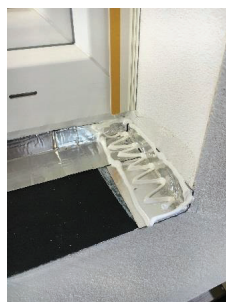

V-2: emv-PVC Slider ALU 25mm passend für alle Alufensterbänke (Slider L)

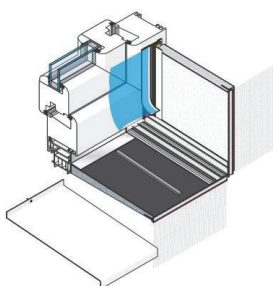



emv AG ▪ Gewerübergreifende Systemlösungen ▪ made in Germany

V-3: emv-PVC Slider NATUR 30mm passend für alle Natursteinbänke (Slider L)

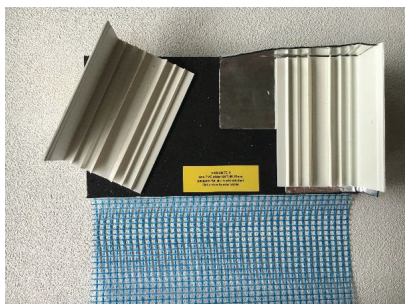

V-3: emv-PVC Slider NATUR 30mm
passend für alle Natursteinbänke (Slider L)

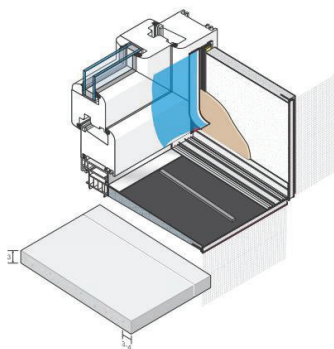



emv AG ▪ Gewerübergreifende Systemlösungen ▪ made in Germany

V-3: emv-PVC Slider NATUR 30mm passend für alle Natursteinbänke (Slider L)



V-4: emv-PVC Slider DESIGN 15mm passend für HELOPAL 15mm (Slider U)



V-4: emv-PVC Slider DESIGN 15mm
passend für HELOPAL 15mm (Slider U)

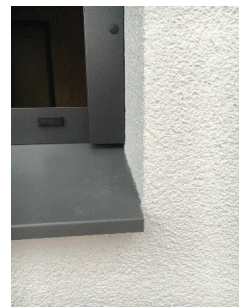



emv AG ▪ Gewerkübergreifende Systemlösungen ▪ made in Germany

V-4: emv-PVC Slider DESIGN 15mm passend für HELOPAL 15mm (Slider U)





emv AG ▪ Gewerübergreifende Systemlösungen ▪ made in Germany

emv-VARIO-WDVS Fensterbankkeil PET/druckstabil für Austrittfensterbänke

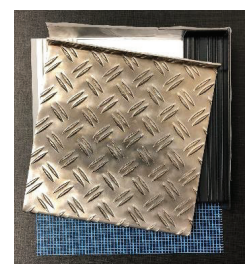
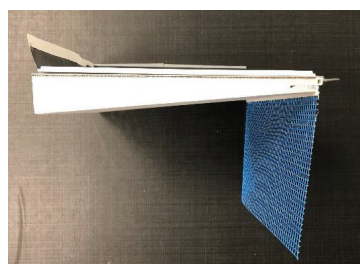
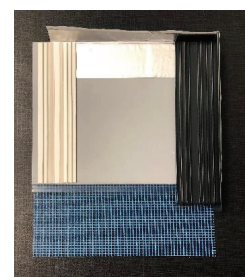
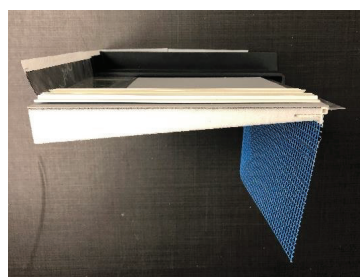

Gütegemeinschaft Wärmedämmung von Fassaden e.V.

Empfehlungen für den Einbau/Ersatz von Metall-Fensterbänken (WDVS-Fassade)

der Gütegemeinschaft Wärmedämmung von Fassaden e.V.

Gütegemeinschaft Wärmedämmung von Fassaden e.V.

Empfehlungen für den Einbau/Ersatz von Naturstein- und Kunststeinfensterbänken (WDVS-Fassade)

der Gütegemeinschaft Wärmedämmung von Fassaden e.V.

Richtlinie Fensterbank

für deren Einbau in WDVS- und Putzfassaden sowie in vorgehängten Fassaden



Österreichische Arbeitsgemeinschaft Fensterbank

2. Ausgabe, 02.05.2014



emv AG ▪ Gewerübergreifende Systemlösungen ▪ made in Germany

emv-VARIO-SlidePro-Kombi-Fensterbanksystem für durchlaufende Fensterbänke

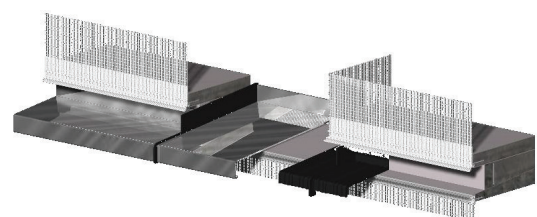
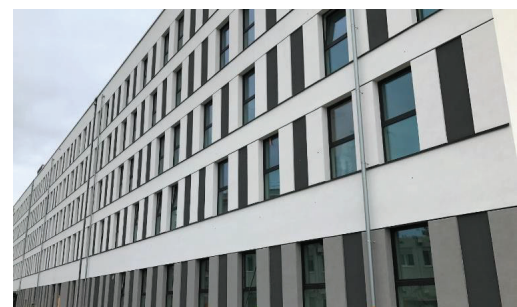



emv AG ▪ Gewerübergreifende Systemlösungen ▪ made in Germany

emv-VARIO-SlidePro-Kombi-Fensterbanksystem für durchlaufende Fensterbänke

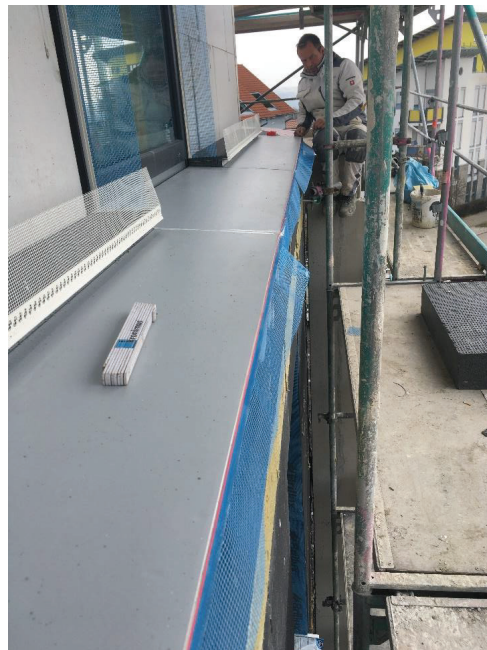



emv AG ▪ Gewerübergreifende Systemlösungen ▪ made in Germany

emv-VARIO-SlidePro-Kombi-Fensterbanksystem für durchlaufende Fensterbänke





emv AG ▪ Gewerübergreifende Systemlösungen ▪ made in Germany

emv-VARIO-SlidePro-Kombi-Fensterbanksystem für durchlaufende Fensterbänke





emv AG ▪ Gewerübergreifende Systemlösungen ▪ made in Germany

emv-VARIO-SlidePro-Kombi-Fensterbanksystem für durchlaufende Fensterbänke

