

YOUNGMAN

INNOVATIVE WORK AT HEIGHT SOLUTIONS

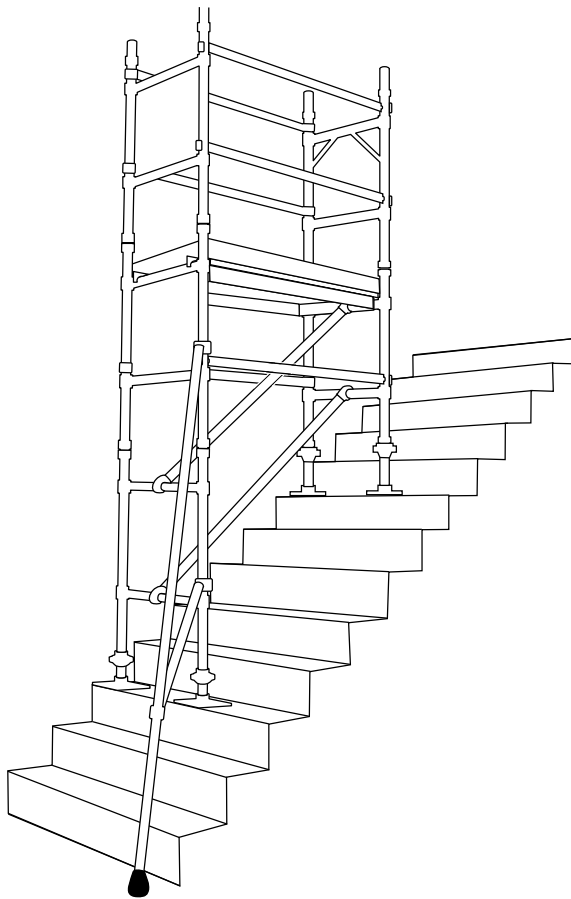

BoSS StairMax 600

USER GUIDE

General Safety

Ensure you read all safety notes before erecting this tower
There is a serious risk of personal injury if you do not follow all instructions laid down in this guide.

- Carry out all necessary risk assessments prior to the use of this equipment.
- This equipment should be used by an able bodied, competent adult who has read and understood these instructions. Anyone with either a temporary or permanent disability should seek expert advice before using it.
- Keep children, animals and bystanders away from the work area.
- Cordon off a NO GO area using cones and either barriers or tape.
- Never use this equipment if you are ill, feeling tired, or under the influence of alcohol or drugs.
- Wear sensible, protective clothing and footwear offering good grip, plus gloves and a hard hat. Tie back long hair and avoid loose garments and jewellery that could get in your way.
- Never work on the tower if you suffer from vertigo.
- Never suspend the tower from another structure.
- Always climb onto the tower from the upper end, entering through the gate in the handrail frame. Keep your feet in the middle of the rungs and grip frame sides firmly with both hands.
- Never carry anything when climbing, unless you can do so leaving both hands free.
- Always check the condition of components before use – and at regular intervals thereafter. If any show signs of damage or excessive wear, do not use them.

Tower Safety

- **Never overload the tower.** The tower's maximum working load is 150kg on the platform. Only one person is allowed on the platform, along with tools and materials.
- **Never lean anything against the tower.**
- **Never use it for jobs that exert repetitive or excessive force.** Lateral forces over 198N – equivalent to a 20kg weight – make it unstable even when fitted with stabilisers or ballast. This section includes a table (a) to indicate what level of lateral force is exerted by typical jobs. Those jobs likely to exert excessive sideways force should not be carried out on this tower, whilst those likely to exert moderate sideways force should be carried out with due care.
- **Never use boxes, steps etc to gain extra height.** Never reach too far out to one side.
- **If the tower is to be repositioned on a higher step,** DO NOT attempt to move it as a complete assembly. Always dismantle it and rebuild at the new location.

General Safety

- **This tower is intended only for indoor use,** and must not be positioned where it could be subjected to wind loads. Ensure that the site or stairwell where it is erected does not induce any funnelling or concentrating effect of the wind, or where opening of doors could introduce sudden wind loads.
- **Ensure that you are not contravening any health and safety law** (blocking a fire exit for example) before proceeding to construct the tower on the stairwell.

Table (A)

Lateral Forces

Typical jobs or tools likely to exert:

Low sideways force

include: Paintbrush, Paint Roller, Wallpapering

Moderate sideways force

include: Driving in Screws, Drilling, Hammering Nails, Chiselling

Excessive sideways force

include: Pneumatic Hand Tools, Demolition Work, Sledgehammer

Assembly Instructions

Make sure that you understand these instructions and are familiar with the tower's components before you begin. It is recommended that you have the help of a second person to assist with the erection process.

Make sure too, that you have everything you need to hand and refer to the illustrations for construction. Check the stabilisation guide and table to ensure that you have the necessary stabiliser(s) or ballast for the site in which you intend to erect the tower.

- 1** Unlock the interlock clips on all frames (see section **Clips and Claws**)
- 2** Fit base plate legs securely to two standard frames. Ensure they are equally extended so that they stand level. These will now be referred to as the base frames.
- 3** Fit an additional frame to one of the base frames and engage the interlock clips. Place the base frame, fitted with an extra frame, on the lower stair and the singular base frame on the upper stair, allowing the correct distance between the frames for the platform to fit (1.3 metres).
- 4** Link these two frames with two horizontal and two diagonal braces as shown in the illustration, to form the tower base – start by clipping the horizontal braces to the frame uprights.

Assembly

5 Fit the platform to the top rungs of the two end frames. Make sure all four platform end hooks are in contact with the top rungs, then secure in place by engaging the hook latches (see illustration). Fit a standard frame to the top end of the frame that is at the lower step, securing it in place with the interlock clips. Fit the gate frame to the top of the frame that is resting on the upper step. Make sure that the access bar is positioned so that it opens in towards the tower.

6 Now attach the four guard rails (see illustration) ensuring that the claws face outward. To complete the tower, the toe boards must be fitted on all four sides of the platform.

7 Now refer to the stabilisation guide and table to use the correct means of stabilising the tower.

The manufacturer strongly recommends that ballast is used in all applications in addition to any method of stabilisation used. Please contact your supplier or hire shop for details.

If stabiliser(s) are required, they must be fitted to the corner(s) of the end frame on the lower step, angled at 45 degrees. The clamps should be fitted to the clear sections of the frame uprights, away from the interlock clips and rungs. Once fitted they must have a minimum sideways extension of 650mm, and also reach down the stairs for a minimum distance of 650mm. Ensure that the rubber foot is firmly in contact with the ground, and that the stabiliser clamps are securely tightened.

1 Clips and Claws

Components are linked using two kinds of fittings

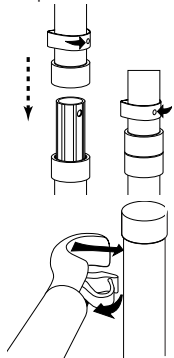

Interlock Clips join frame uprights. Unlock those on the frame to be added, fit its sockets over the spigots of the lower frame and re-lock the clips.

Locking Claws join brace to frame. Pull back the trigger to open the jaws, then snap the claw onto the rail or upright, ensuring the open side faces down or out. The jaws should lock automatically.

Whichever fitting you are using, though, always double-check that it is locked and secure before continuing.

2

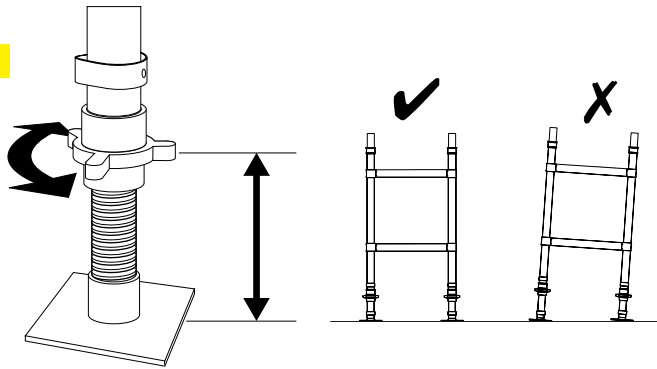

3

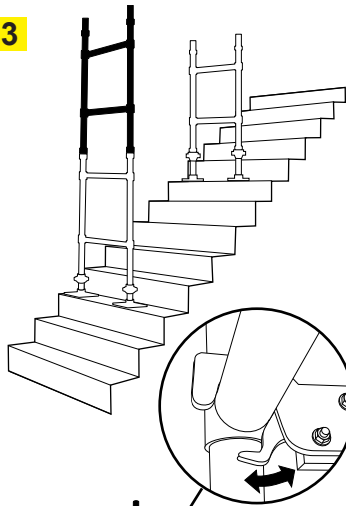

4

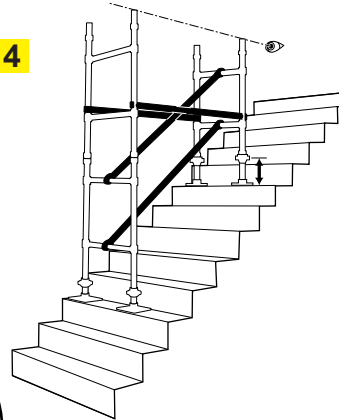

5

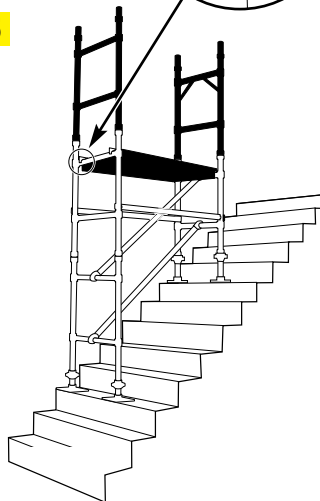

6

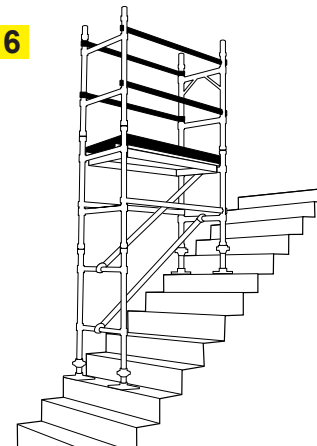

Stabilisation Guide

Refer to the table below for the correct method(s) of stabilising the tower for the stairwell in which you intend to erect it:

Position of tower in Stairwell	Staircase Clear Width		
	0.8 to 1.4m	1.4 to 2.0m	2.0m or greater
Free-Standing (No walls on either side of staircase)	A	A	A or C
Up against a wall on one side of the staircase	A or D	A or B or D	A or B or D
Mid-way between walls on each side of staircase	A or D	A or D	A or C

For additional stability more than one stabilisation method may be used. **The manufacturer strongly recommends that ballast be used** in all applications in addition to the alternative methods indicated by this guide.

Methods of stabilisation:

A Strongly recommended: The tower is fitted with 150kg of ballast uniformly spread along the bottom rung of each base frame (i.e. 75kg at each end). Please contact your supplier or hire shop for details.

B The tower is positioned up against a wall on one side, and a stabiliser is fitted on the other, to the end frame on the lower step. The stabiliser must have a minimum sideways extension of 650mm, and reach down the stairs for a minimum distance of 650mm.

C The tower is fitted with a stabiliser on both sides, each with a minimum sideways extension of 650mm, and reaching down the stairs for a minimum distance of 650mm. Additional stabiliser available from your supplier or hire shop.

D The tower is fixed solidly to a wall on one side with ties. They should be rigid, two-way ties fastened to both uprights of the frame with load bearing right-angled or swivel couplers. Only couplers suitable for the 50.8mm diameter tube of the tower should be used. Ideally ties should secure to either the face of a solid structure or by means of anchorages. Tying in with rope or non-rigid members is not acceptable.

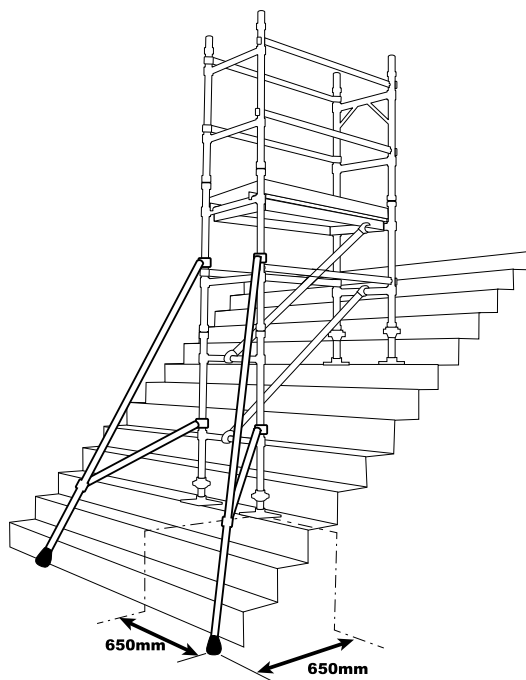

Equipment Care

Never use the tower for anything other than its intended purpose as a work platform.

Keep the tower clean, paying special attention to the deck. You will find this easier if you clean up regularly.

When not in use, store everything somewhere clean, dry and safe.

Finishing Off

To dismantle the tower, start at the top and work down, reversing the erection procedure.

Work through the steps in strict sequence.

Components can be damaged by the use of excessive force. Do not use hammers, etc. to force joints apart.

Always lower components to the ground carefully when dismantling the tower. Never simply drop them as damage or serious personal injury may occur.

Construction Checklist

Before using the tower, always double-check that...
Component condition checked

- Legs correctly adjusted
- Tower uprights are vertical
- All braces fitted are locked
- Handrails fitted are locked
- Platforms fitted are locked and level
- Correct method(s) of stabilisation used

Component Checklist

- Standard Frame (x4)
- Gate Frame (x1)
- Platform (x1)
- Horizontal Brace (x6)
- Diagonal Brace (x2)
- Stabiliser (x1)
- Adjustable Leg (x4)
- Base Plate (x4)
- End Toeboard (x2)
- Side Toeboard (x2)

Tower Dimensions

- Maximum safe working height 3.7m
- Maximum overall height 3.5m
- Maximum platform height 2.3m
- Maximum tower length 1.45m
- Maximum tower width 0.7m
- Complete tower weight (no stabiliser) 52Kg
- Stabiliser 6Kg

For further information about this product or any other products and services, please contact :

Youngman Group Ltd
The Causeway, Maldon,
Essex, CM9 4LJ,
United Kingdom

t +44 (0)1621 745900
f +44 (0)1621 859845
e sales@youngmangroup.com