

Les plus produit:

- Matière - sapin du nord naturel, prêt à traiter;
- Porte menuisère double / semi vitrée / vitrage en verre avec croisillons, poignée et serrure à cylindre, largeur: 1,42 m / hauteur: 1,90 m;
- Seuil de la porte en aluminium;
- Porte est équipée d'un joint d'isolation;
- Toiture en bois massif 18 mm / couverture de toit en rouleau de toile bitumée (épaisseur 3,6 mm). Toiture à couvrir: 7,0 m²;
- Lisse basse incluse.



CONDITIONEMENT:

Dimensions mini de la dalle en béton: 2,28x1,78 m
Surface à traiter: 40m²

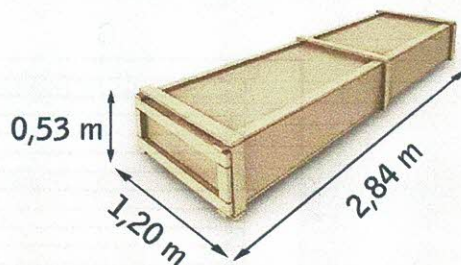
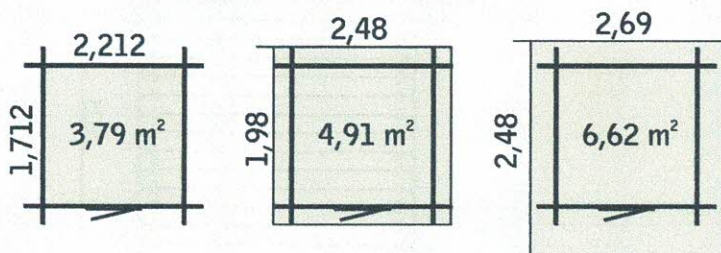

Poids brut: 495kg

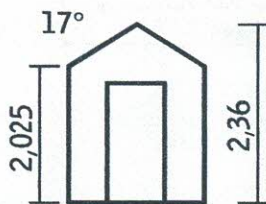

La marque de la gestion forestière responsable

1399 € TTC

ABRI DU JARDIN BOIS KIT
emboîté 2,5 x 2,0 m Ep. 34 mm

COLZA 4

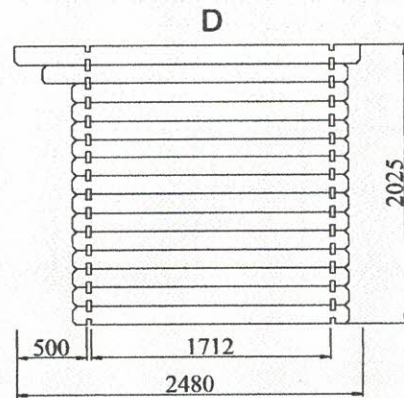
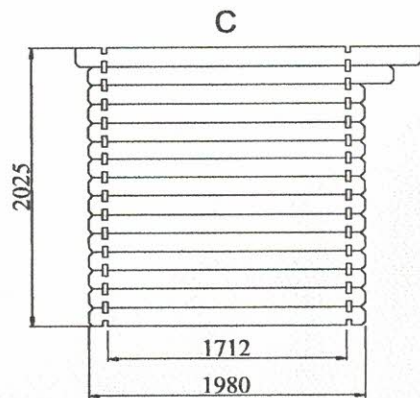
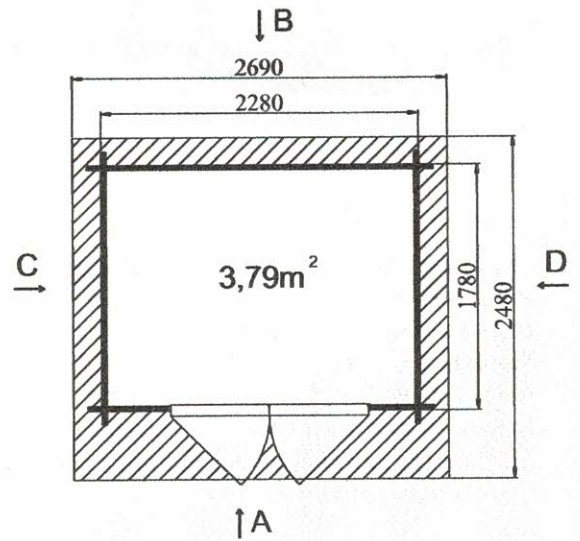
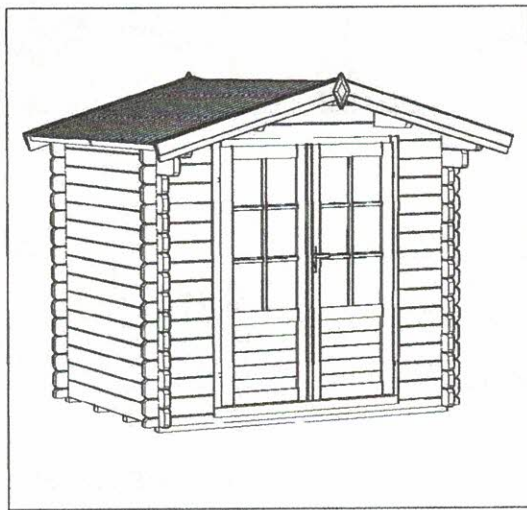
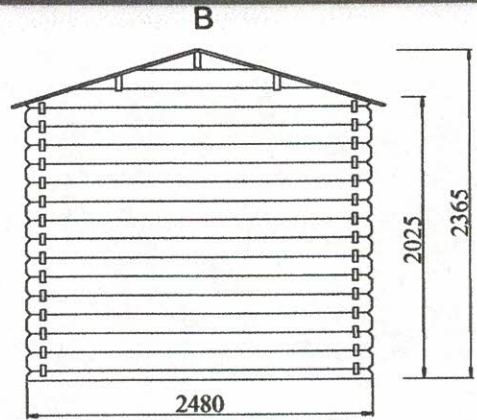
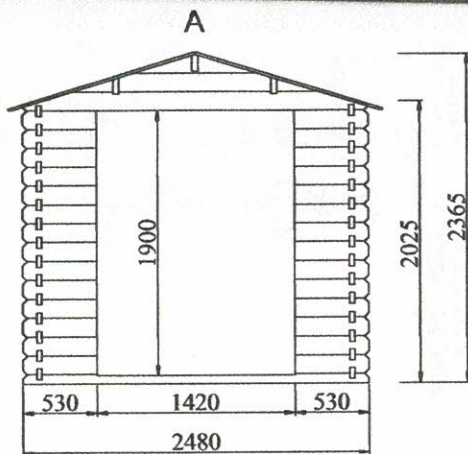

Abri
Bois Kit



FSC
www.fsc.org
FSC® C041523

La marque de la
gestion forestière
responsable



Les plus produit:

- Matière - sapin du nord naturel, prêt à traiter;
- Porte menuisère double / semi vitrée / vitrage en verre avec croisillons, poignée et serrure à cylindre, largeur: 1,42 m / hauteur: 1,90 m;
- Seuil de la porte en aluminium;
- Porte est équipée d'un joint d'isolation;
- Toiture en bois massif 18 mm / couverture de toit en rouleau de toile bitumée (épaisseur 3,6 mm). Toiture à couvrir: 8,4 m²;
- Lisse basse incluse.



CONDITIONEMENT:

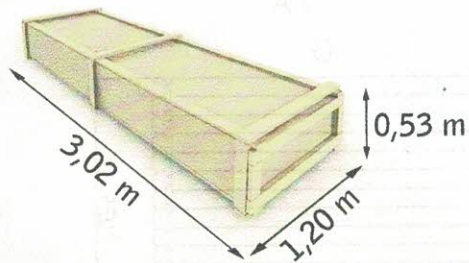

Poids brut: 560 kg

Dimensions mini de la dalle en béton: 2,28x2,28 m
Surface à traiter: 44m²

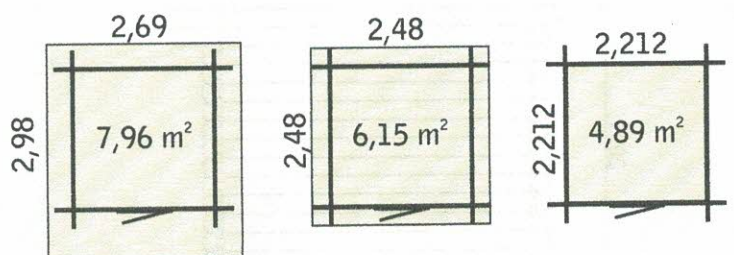

La marque de la
gestion forestière
responsable

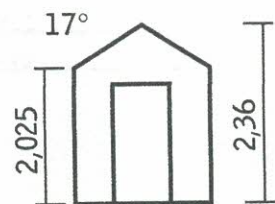

1595€ TTC

ABRI DU JARDIN BOIS KIT
emboîté 2,5 x 2,5 m Ep. 34 mm

COLZA 5

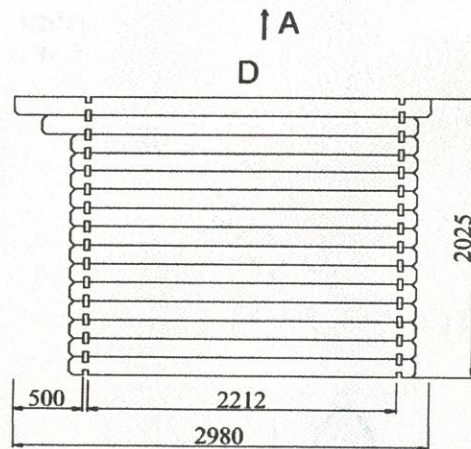
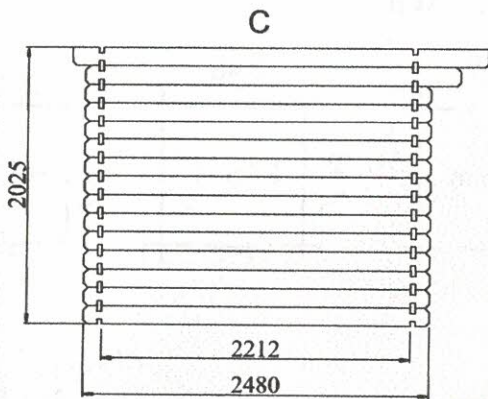
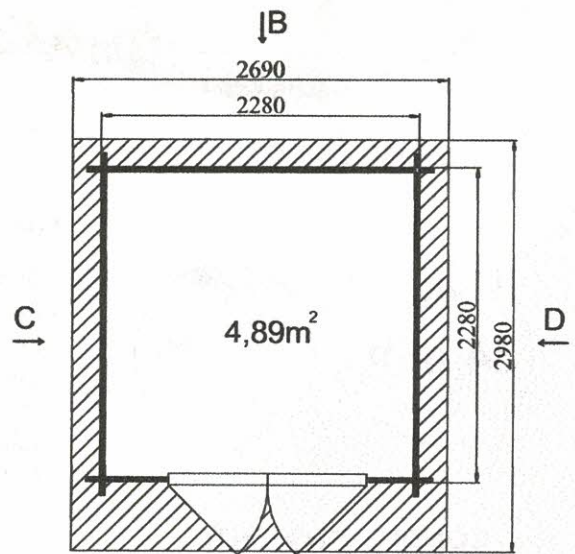
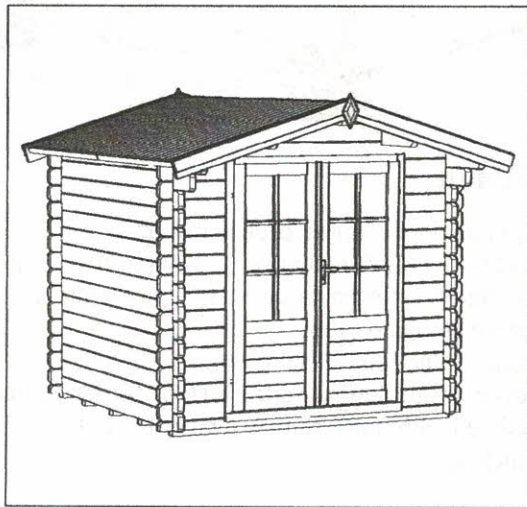
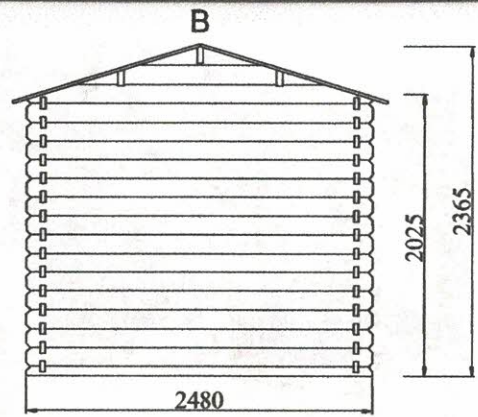
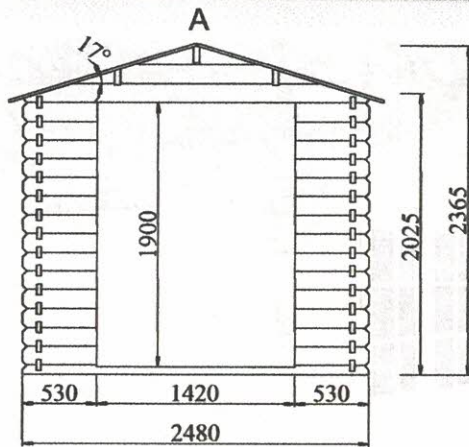

La marque de la
gestion forestière
responsable



Les plus produit:

- Matière - sapin du nord naturel, prêt à traiter;
- Porte menuisère double / semi vitrée / vitrage en verre avec croisillons, poignée et serrure à cylindre, largeur: 1,42 m / hauteur: 1,90 m;
- Seuil de la porte en aluminium;
- Porte est équipée d'un joint d'isolation;
- Toiture en bois massif 18 mm / couverture de toit en rouleau de toile bitumée (épaisseur 3,6 mm). Toiture à couvrir: 9,9 m²;
- Lisse basse incluse.



CONDITIONEMENT:

Dimensions mini de la dalle en béton: 2,78x2,28 m
Surface à traiter: 49 m²

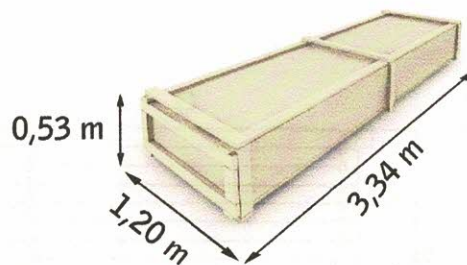
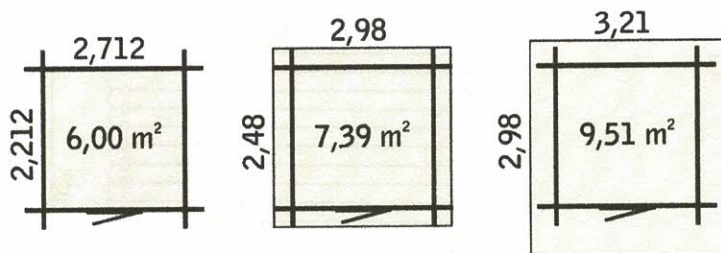

Poids brut: 620 kg

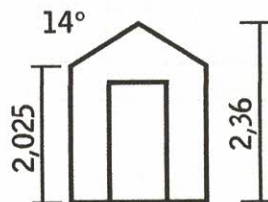

La marque de la
gestion forestière
responsable



1720 € TTC

ABRI DU JARDIN BOIS KIT
emboité 3,0 x 2,5 m Ep. 34 mm

OLIVIER 6

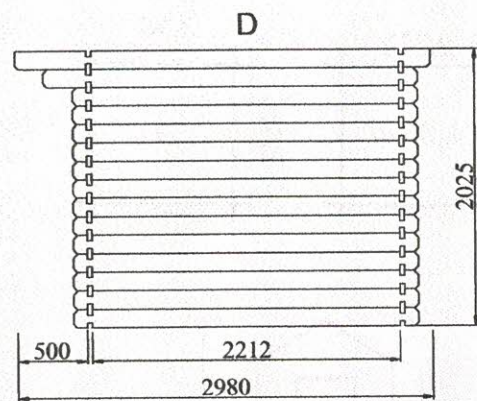
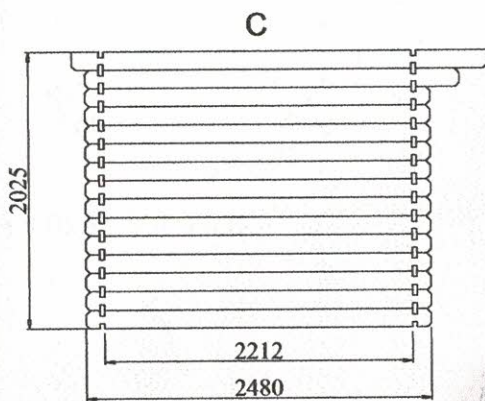
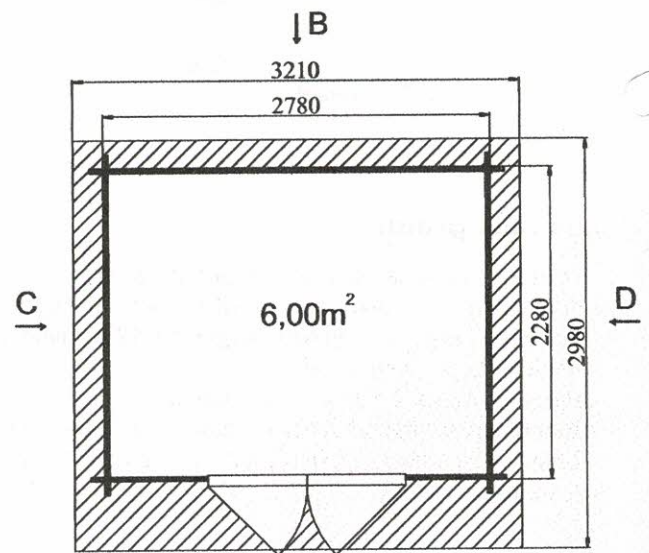
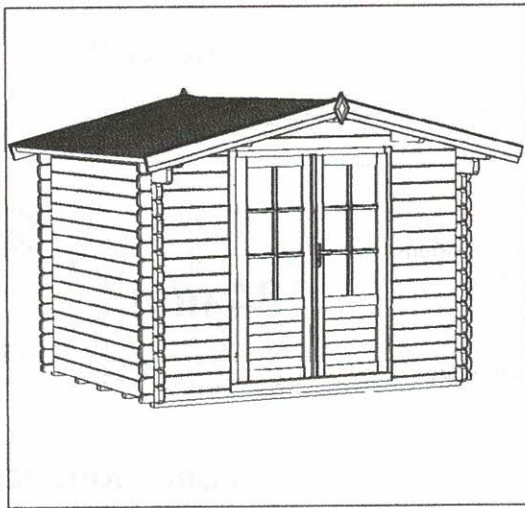
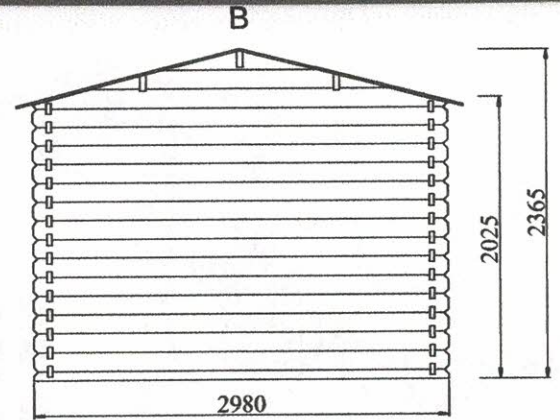
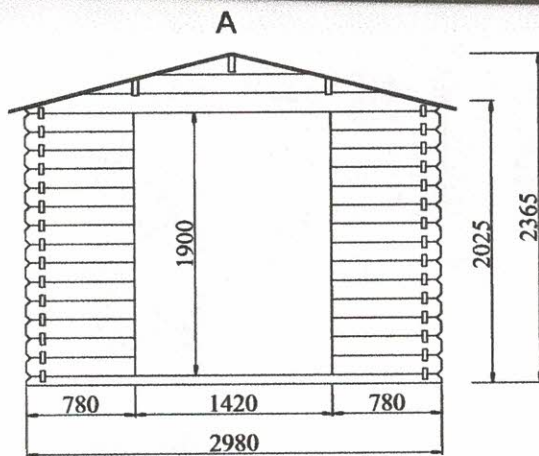

La marque de la
gestion forestière
responsable



Les plus produit:

- Matière - sapin du nord naturel, prêt à traiter;
- Porte menuisère double / semi vitrée / vitrage en verre avec croisillons, poignée et serrure à cylindre, largeur: 1,42 m / hauteur: 1,90 m;
- Seuil de la porte en aluminium;
- Porte est équipée d'un joint d'isolation;
- Toiture en bois massif 18 mm / couverture de toit en rouleau de toile bitumée (épaisseur 3,6 mm). Toiture à couvrir: 11,5 m²;
- Lisse basse incluse.



CONDITIONEMENT:

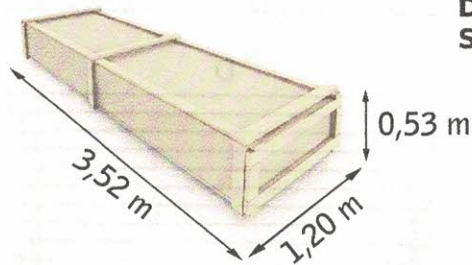

Poids brut: 685 kg

Dimensions mini de la dalle en béton: 2,78x2,78 m
Surface à traiter: 53 m²

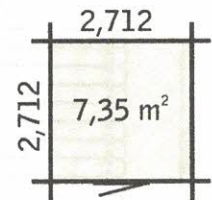
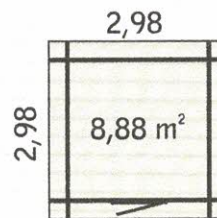
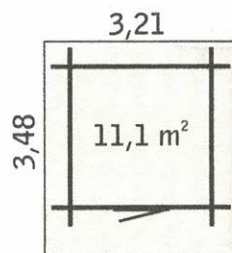

La marque de la
gestion forestière
responsable

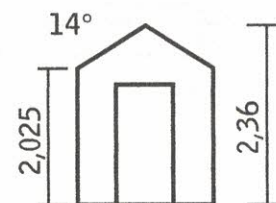

1868 € TTC

ABRI DU JARDIN BOIS KIT
emboîté 3,0 x 3,0 m Ep. 34 mm

OLIVIER 7

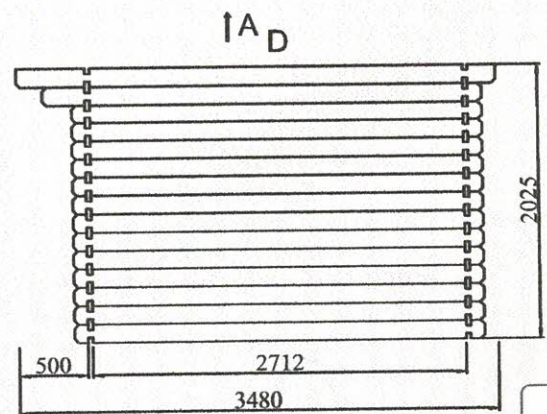
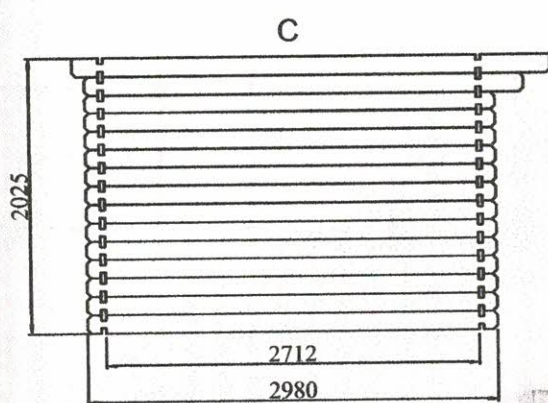
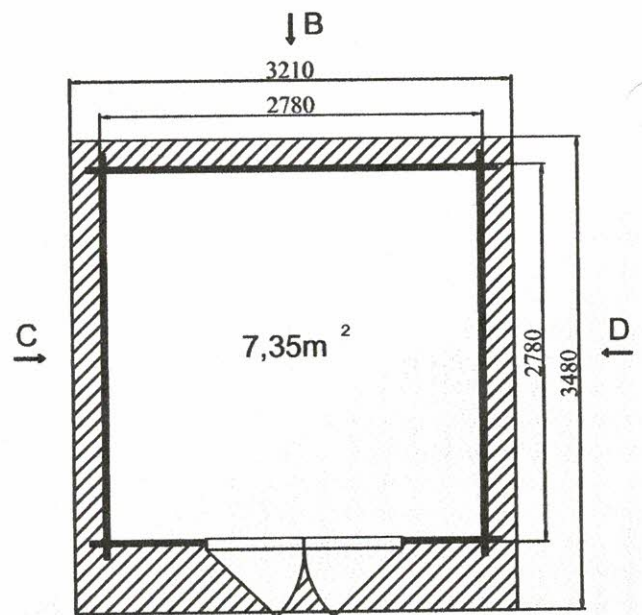
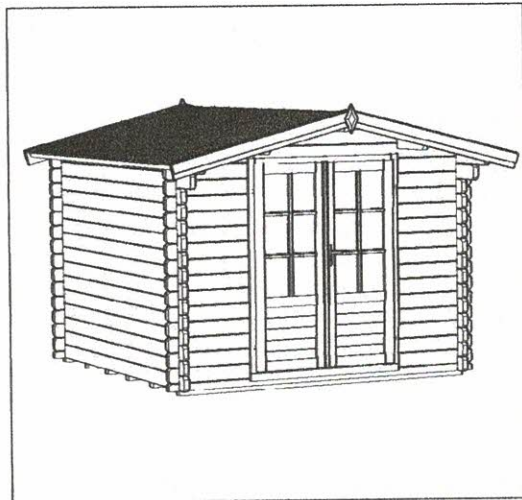
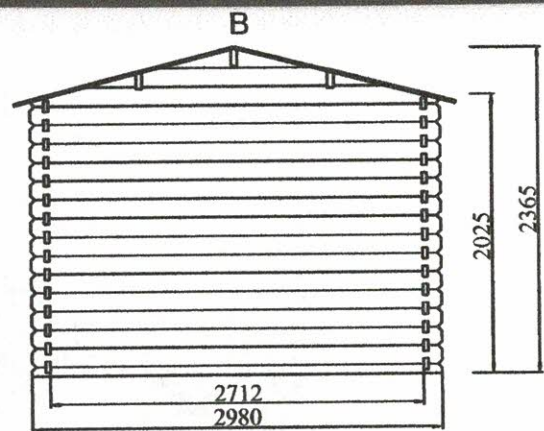
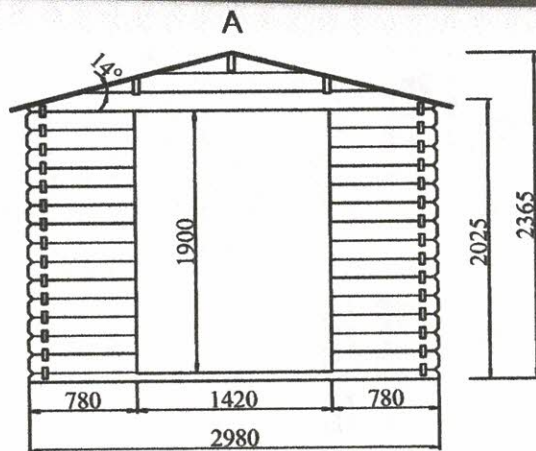



Les plus produit:

- Matière - sapin du nord naturel, prêt à traiter;
- Porte menuisère double / semi vitrée / vitrage en verre avec croisillons, poignée et serrure à cylindre, largeur: 1,42 m / hauteur: 1,90 m;
- Fenêtre simple / oscillo-battante / vitrage en verre avec croisillons, largeur: 0,72 m / hauteur: 0,94 m. Paire de volets et jardinière incluse;
- Seuil de la porte et seuil de la fenêtre anti goutte en aluminium;
- Chaque fenêtre et porte est équipée d'un joint d'isolation;
- Toiture en bois massif 18 mm / couverture de toit en rouleau de toile bitumée (épaisseur 3,6 mm). Toiture à couvrir: 11,6 m²;
- Lisse basse incluse.



CONDITIONNEMENT:

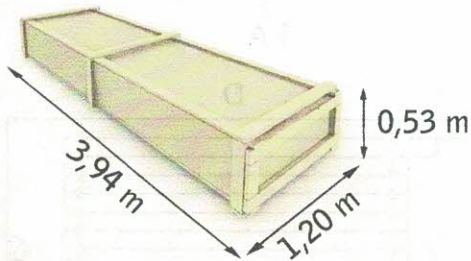

Poids brut: 710 kg

Dimensions mini de la dalle en béton: 3,28x2,28 m
Surface à traiter: 57 m²

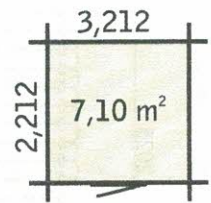
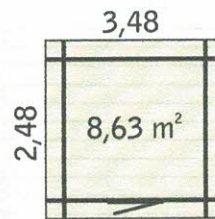
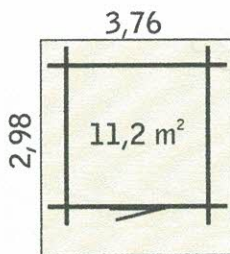

La marque de la
gestion forestière
responsable

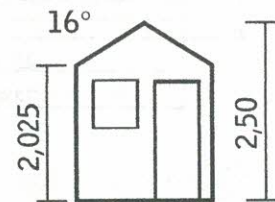

1967€ TTC

ABRI DU JARDIN BOIS KIT
emboîté 3,5 x 2,5 m Ep. 34 mm

PRUNES 7

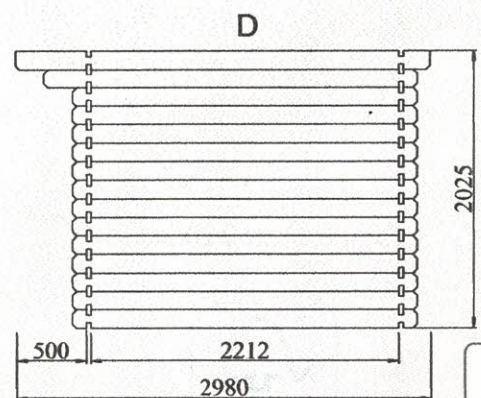
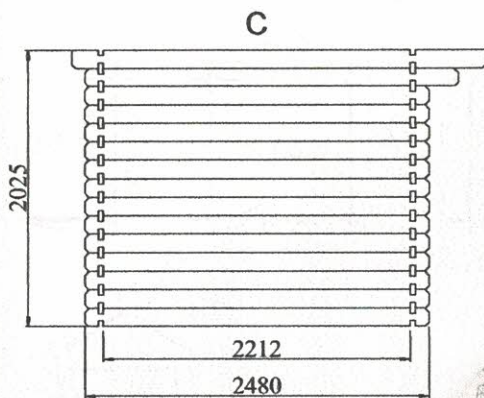
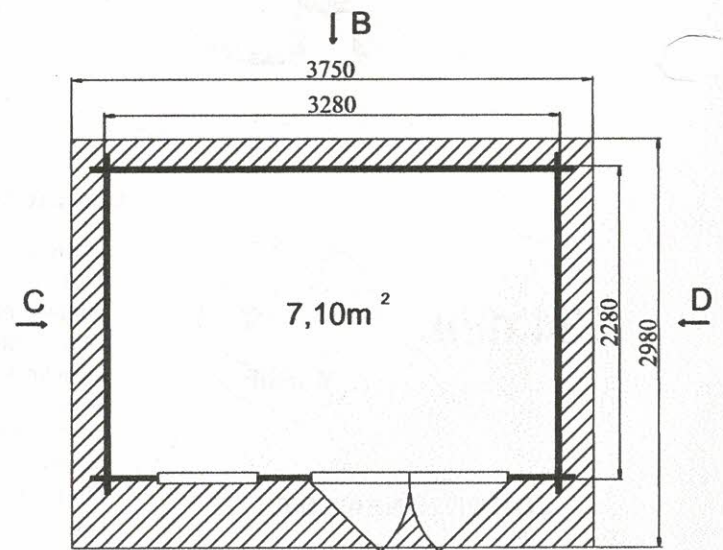
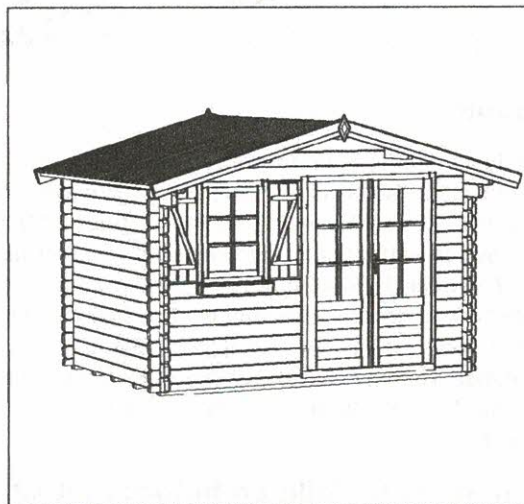
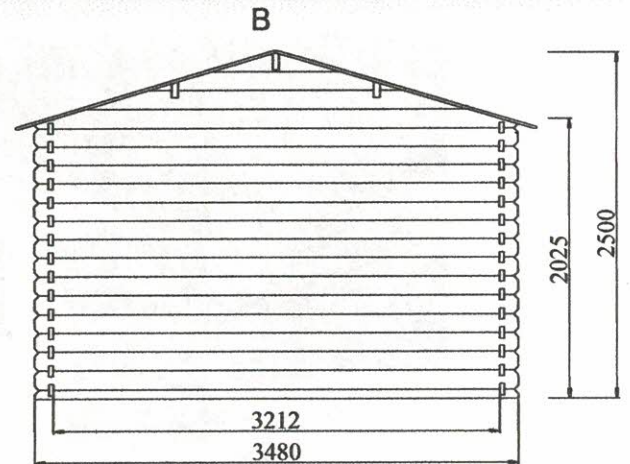
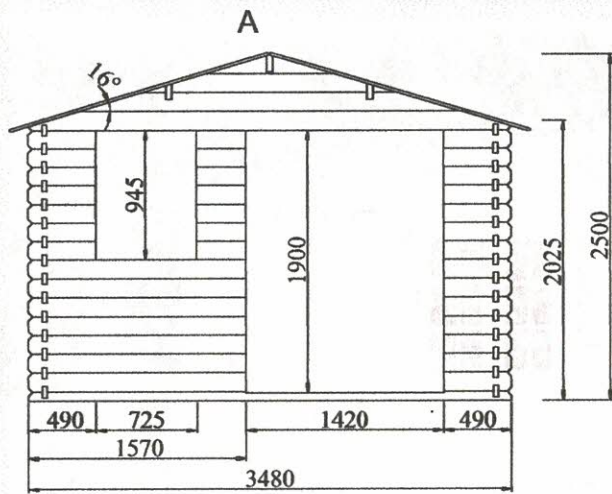

La marque de la
gestion forestière
responsable

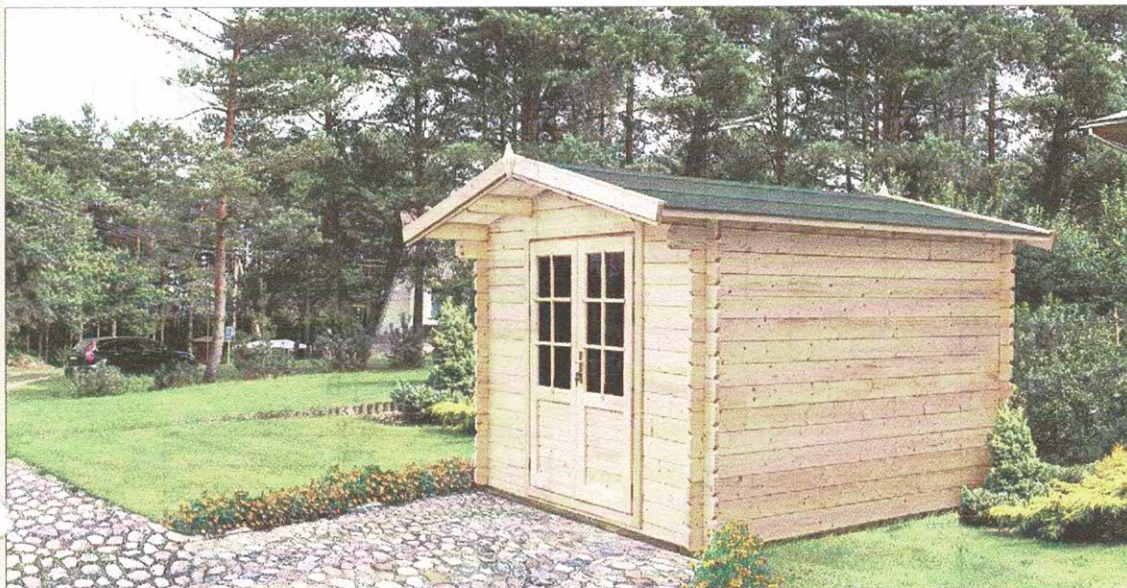

Les plus produit:

- Matière - sapin du nord naturel, prêt à traiter;
- Porte menuisère double / semi vitrée / vitrage en verre avec croisillons, poignée et serrure à cylindre, largeur: 1,42 m / hauteur: 1,90 m;
- Seuil de la porte en aluminium;
- Porte est équipée d'un joint d'isolation;
- Toiture en bois massif 18 mm / couverture de toit en rouleau de toile bitumée (épaisseur 3,6 mm). Toiture à couvrir: 13,2 m²;
- Lisse basse incluse.



CONDITIONEMENT:

Dimensions mini de la dalle en béton: 2,78x3,28 m
Surface à traiter: 58 m²

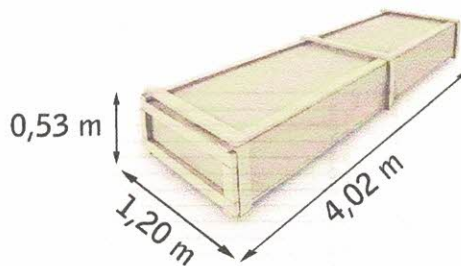
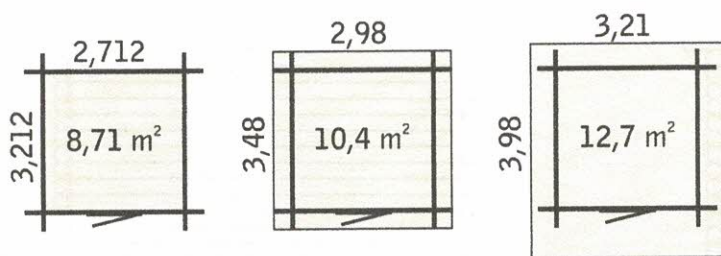

Poids brut: 750 kg

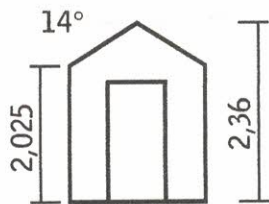

La marque de la gestion forestière responsable



1999 € TTC

ABRI DU JARDIN BOIS KIT
emboîté 3,0 x 3,5 m Ep. 34 mm

OLIVIER 9

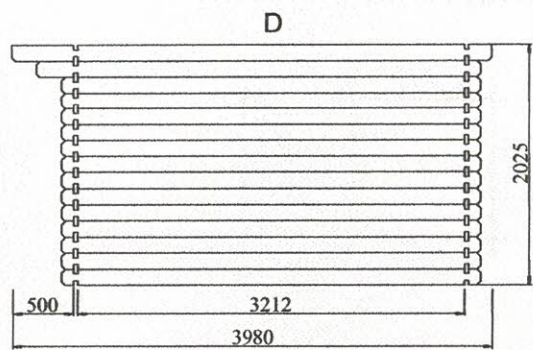
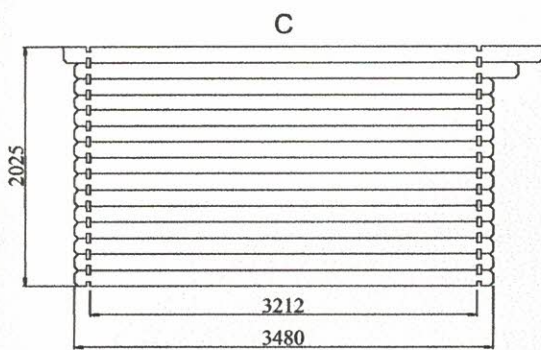
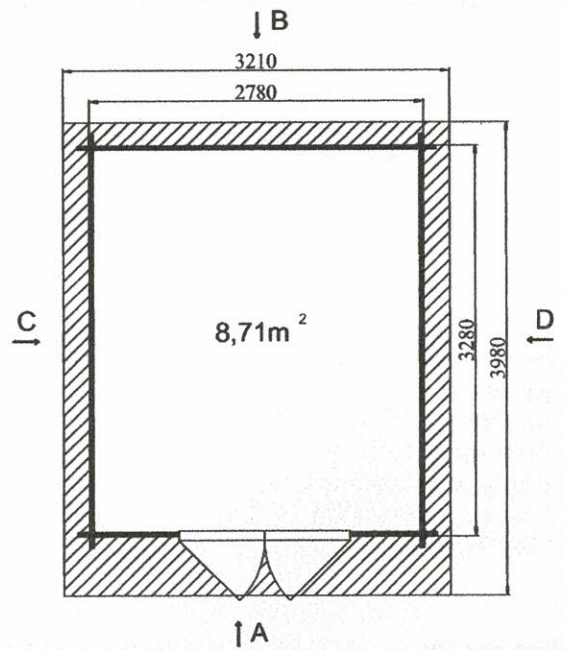
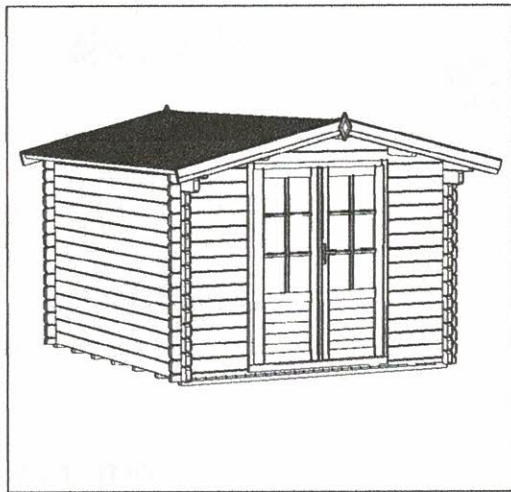
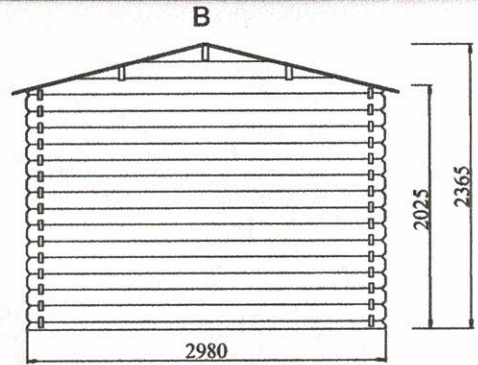
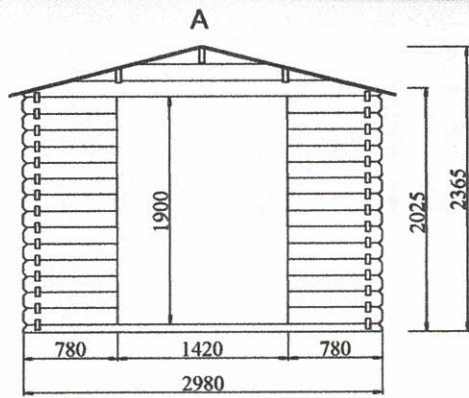

La marque de la
gestion forestière
responsable



Les plus produit:

- Matière - sapin du nord naturel, prêt à traiter;
- Porte menuisère double / semi vitrée / vitrage en verre avec croisillons, poignée et serrure à cylindre, largeur: 1,42 m / hauteur: 1,90 m;
- Fenêtre simple / oscillo-battante / vitrage en verre avec croisillons, largeur: 0,72 m / hauteur: 0,94 m. Paire de volets et jardinière incluse;
- Seuil de la porte et seuil de la fenêtre anti goutte en aluminium;
- Chaque fenêtre et porte est équipée d'un joint d'isolation;
- Toiture en bois massif 18 mm / couverture de toit en rouleau de toile bitumée (épaisseur 3,6 mm). Toiture à couvrir: 15,6 m²;
- Lisse basse incluse.



CONDITIONEMENT:

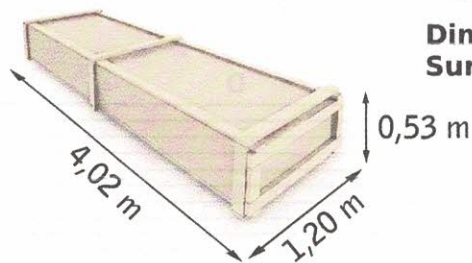

Poids brut: 845 kg

Dimensions mini de la dalle en béton: 3,28x3,28 m
Surface à traiter: 67 m²

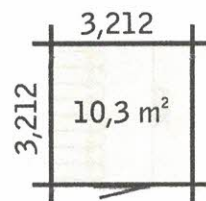
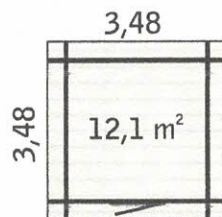
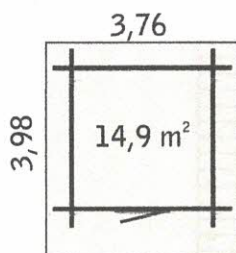

La marque de la gestion forestière responsable

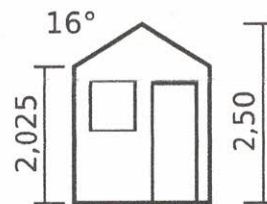

2217 € TTC

ABRI DU JARDIN BOIS KIT
emboîté 3,5 x 3,5 m Ep. 34 mm

PRUNES 10

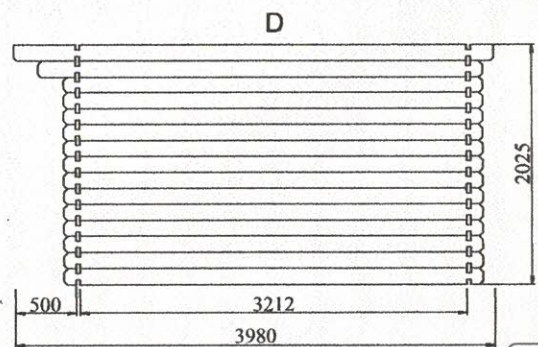
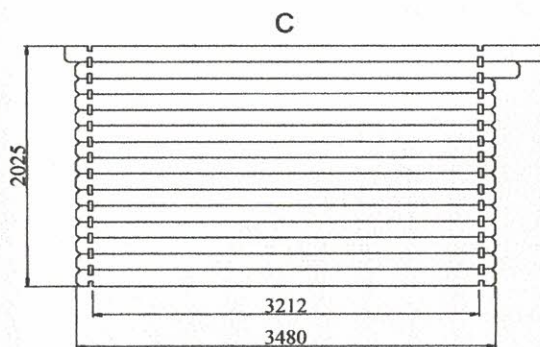
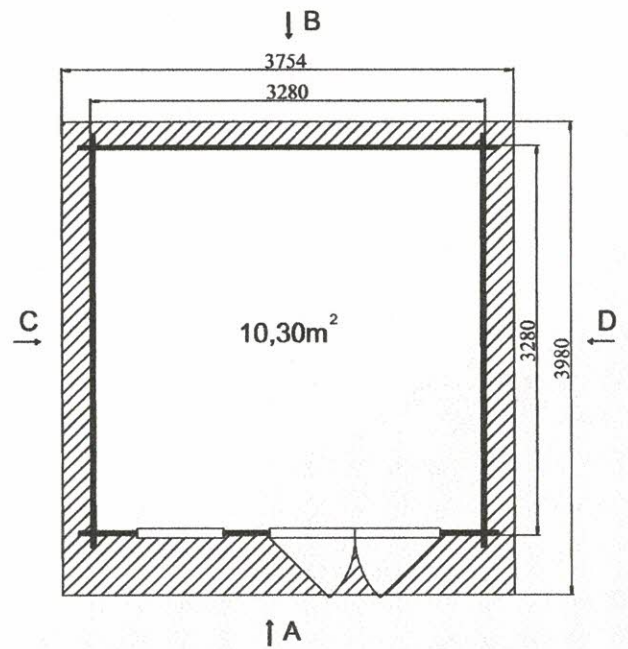
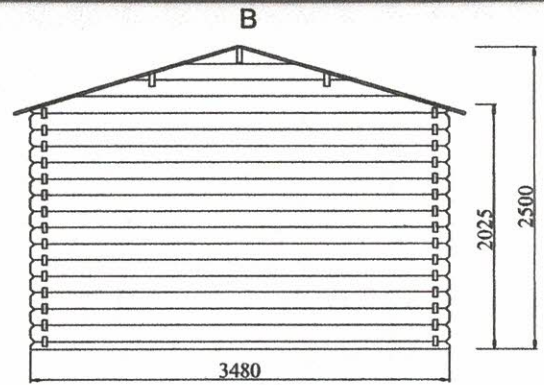
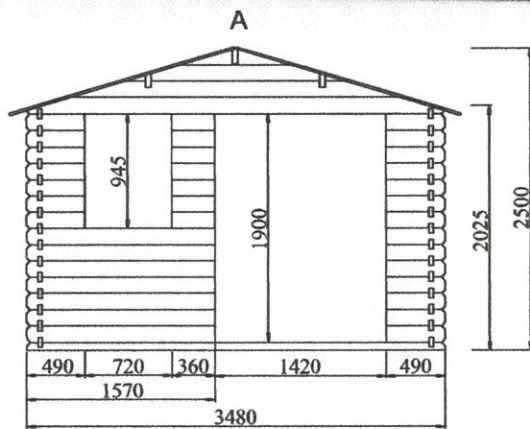

La marque de la
gestion forestière
responsable



Les plus produit:

- Matière - sapin du nord naturel, prêt à traiter;
- Porte menuisère double / vitrée / vitrage en verre opaque, poignée et serrure à cylindre, largeur: 1,42 m / hauteur: 1,95 m;
- 3 fenêtres simples / fixe / vitrage en verre opaque, largeur: 0,66 m / hauteur: 0,40 m;
- Seuil de la porte en aluminium;
- Porte est équipée d'un joint d'isolation;
- Toiture en bois massif 18 mm / couverture de toit en rouleau de toile bitumée (épaisseur 3,6 mm). Toiture à couvrir: 19,2 m²;
- Lisse basse incluse.
- Plancher en option.



Dimensions mini de la dalle en béton: 2,78x2,78 m
Surface à traiter: 85 m²

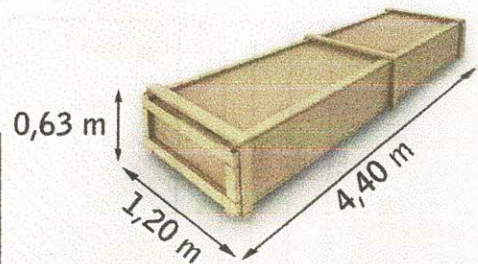
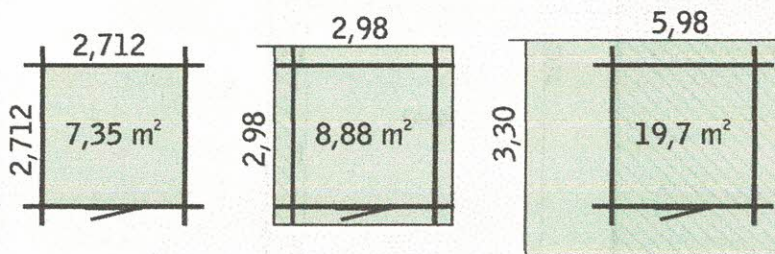

CONDITIONNEMENT:

Poids brut: 870 kg

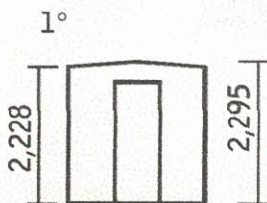

La marque de la gestion forestière responsable

2260 € TTC

ABRI DU JARDIN BOIS KIT
emboîté 3,0 x 3,0 m Ep. 34 mm

AILANTE 7 v34

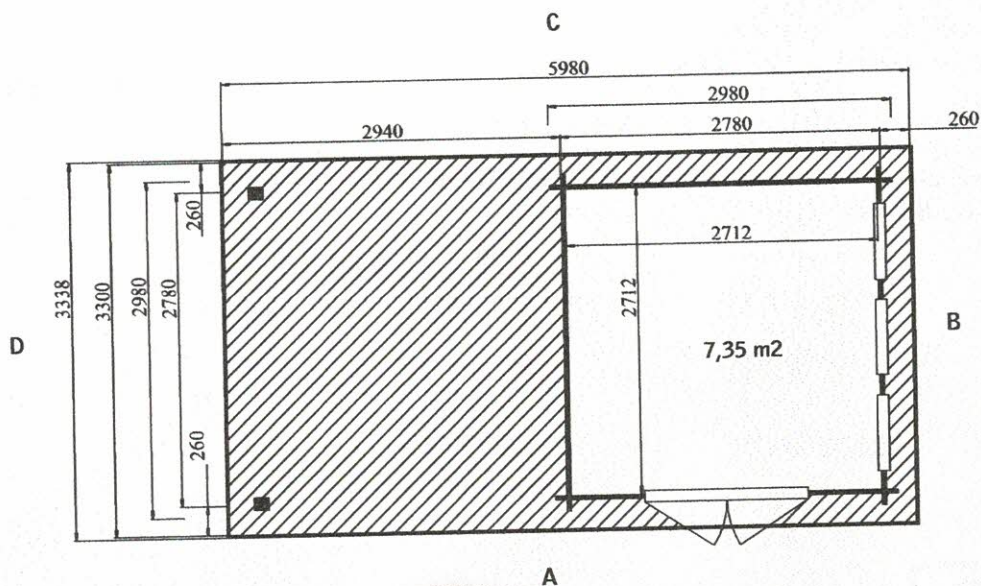
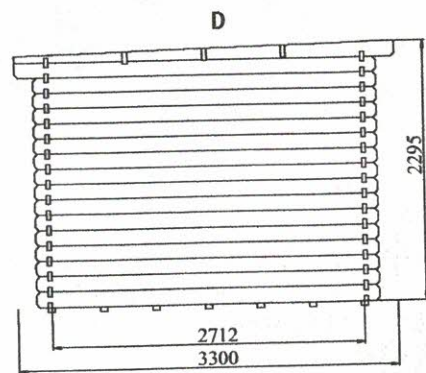
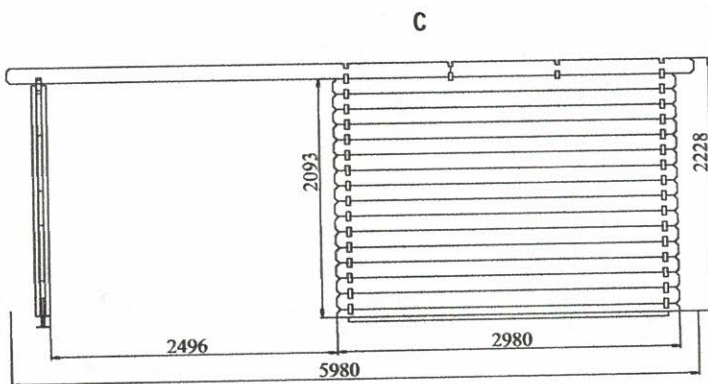
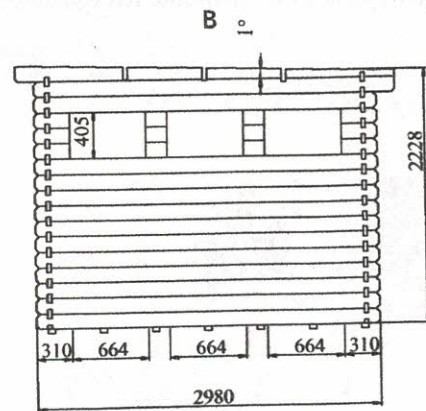
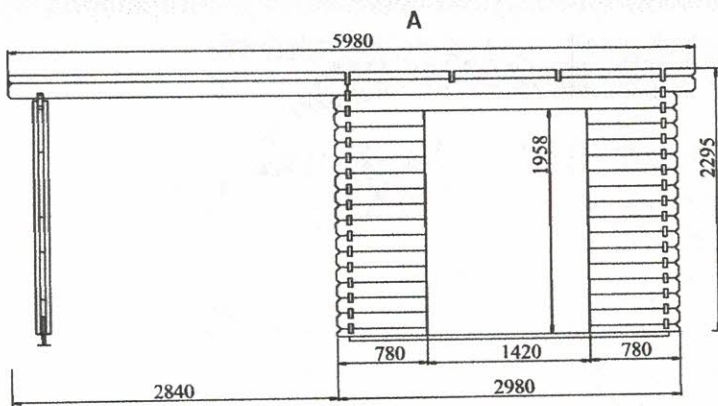



Les plus produit:

- Matière - sapin du nord naturel, prêt à traiter;
- Porte menuisère double / semi vitrée / vitrage en verre avec croisillons, poignée et serrure à cylindre, largeur: 1,42 m / hauteur: 1,90 m;
- Fenêtre simple / oscillo-battante / vitrage en verre avec croisillons, largeur: 0,72 m / hauteur: 0,94 m. Paire de volets et jardinière incluse;
- Seuil de la porte et seuil de la fenêtre anti goutte en aluminium
- Chaque fenêtre et porte est équipée d'un joint d'isolation;
- Toiture en bois massif 18 mm / couverture de toit en rouleau de toile bitumée (épaisseur 3,6 mm). Toiture à couvrir: 17,5 m²;
- Lisse basse incluse.



Dimensions mini de la dalle en béton: 3,28x3,78 m
Surface à traiter: 72 m²

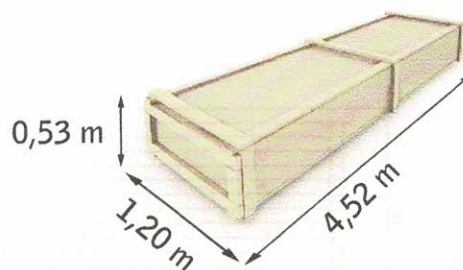
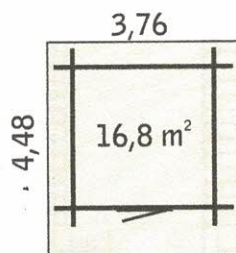
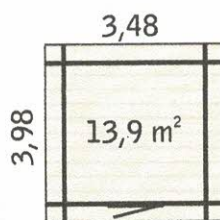
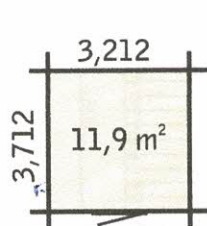

Poids brut: 910 kg

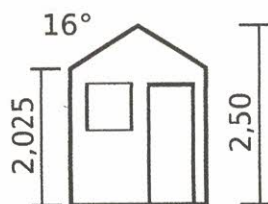

La marque de la gestion forestière responsable

2394 € TTC

ABRI DU JARDIN BOIS KIT
emboité 3,5 x 4,0 m Ep. 34 mm

PRUNES 12

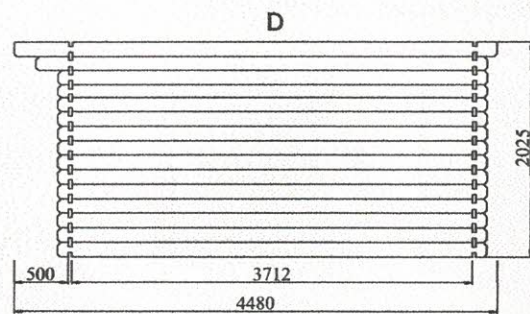
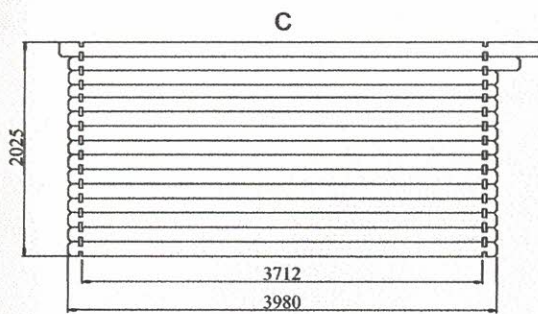
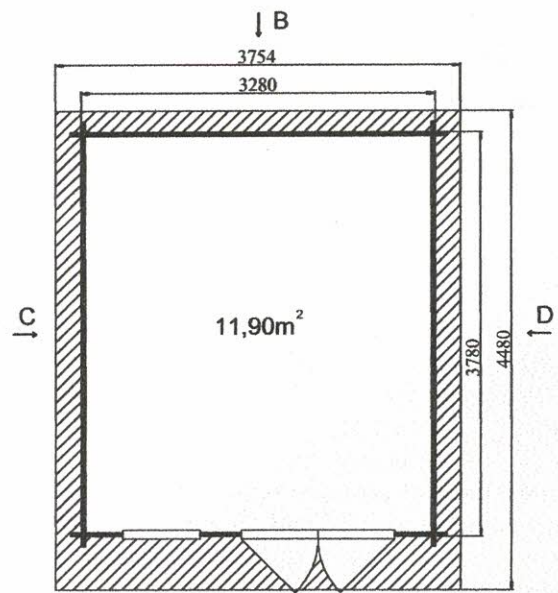
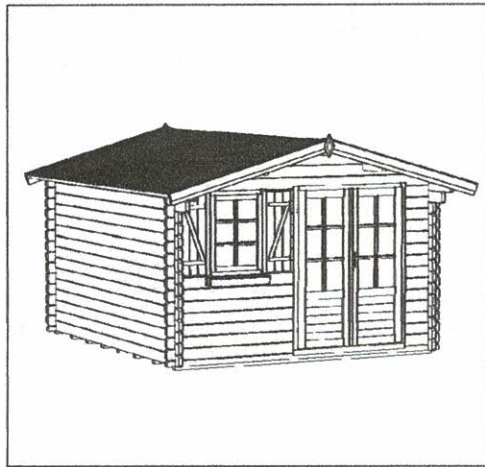
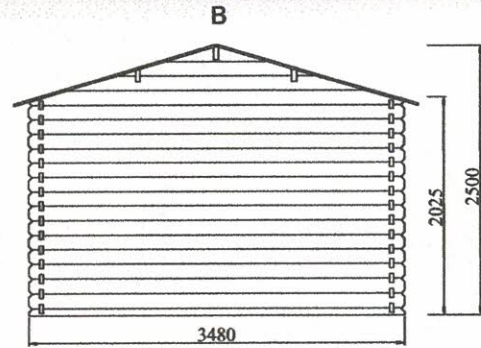
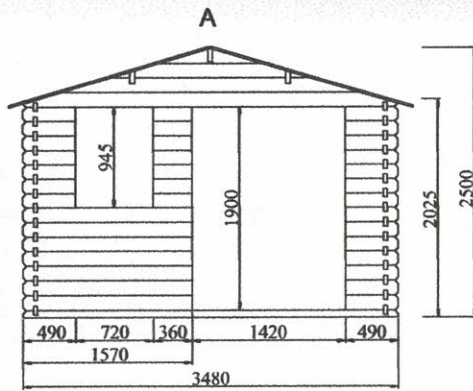

La marque de la
gestion forestière
responsable

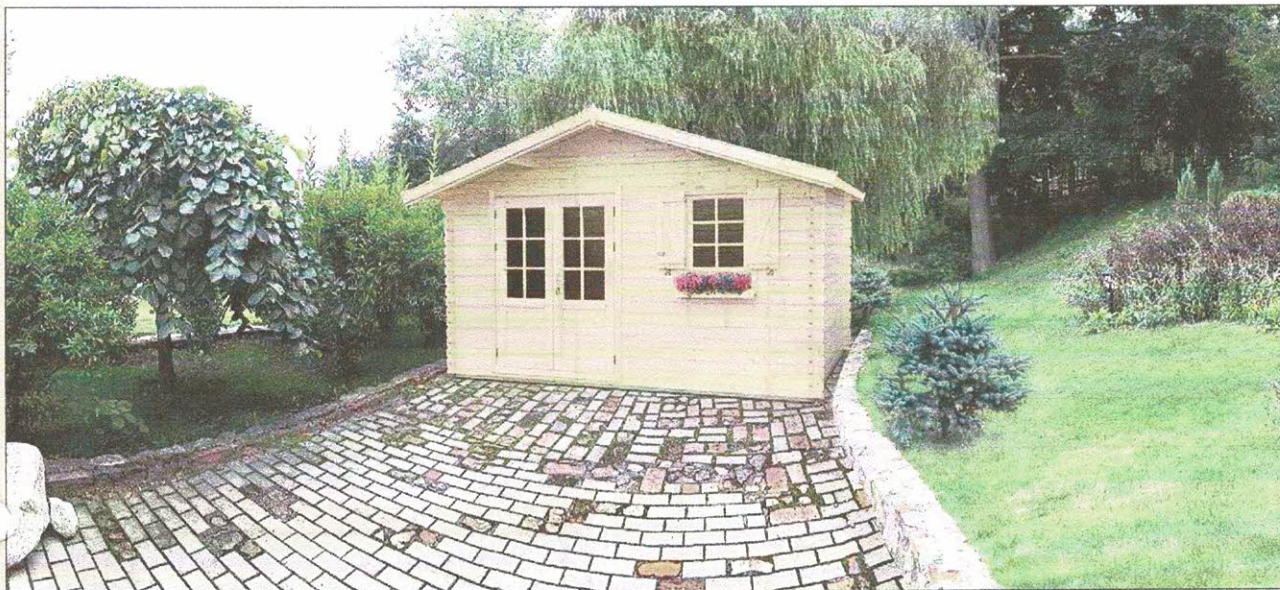

Les plus produit:

- Matière - sapin du nord naturel, prêt à traiter;
- Porte menuisère double / semi vitrée / vitrage en verre avec croisillons, poignée et serrure à cylindre, largeur: 1,42 m / hauteur: 1,90 m;
- Fenêtre simple / oscillo-battante / vitrage en verre avec croisillons, largeur: 0,72 m / hauteur: 0,94 m. Paire de volets et jardinière incluse;
- Seuil de la porte et seuil de la fenêtre anti goutte en aluminium;
- Chaque fenêtre et porte est équipée d'un joint d'isolation;
- Toiture en bois massif 18 mm / couverture de toit en rouleau de toile bitumée (épaisseur 3,6 mm). Toiture à couvrir: 19,8 m²;
- Lisse basse incluse.



Dimensions mini de la dalle en béton: 3,78x3,78 m
Surface à traiter: 78 m²

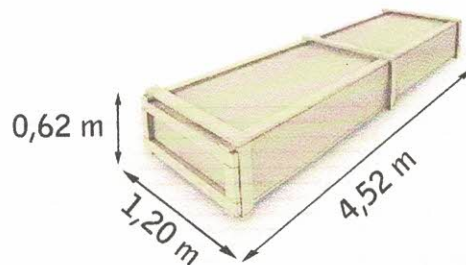
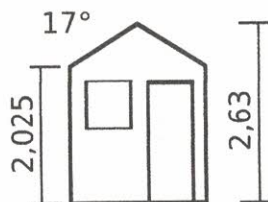
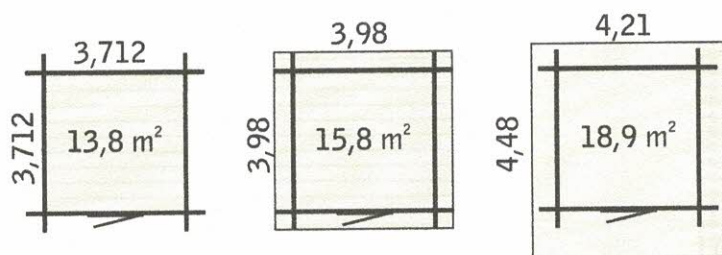

Poids brut: 1000 kg



La marque de la gestion forestière responsable



2563 € TTC

ABRI DU JARDIN BOIS KIT
emboité 4,0 x 4,0 m Ep. 34 mm

POMMIER 14

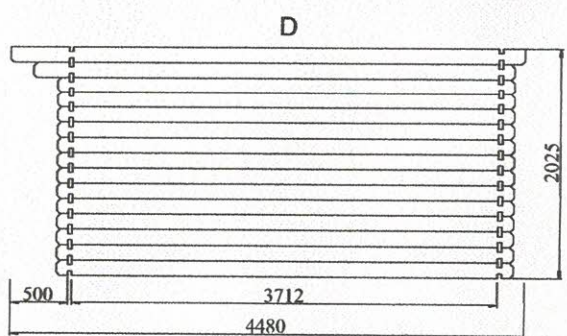
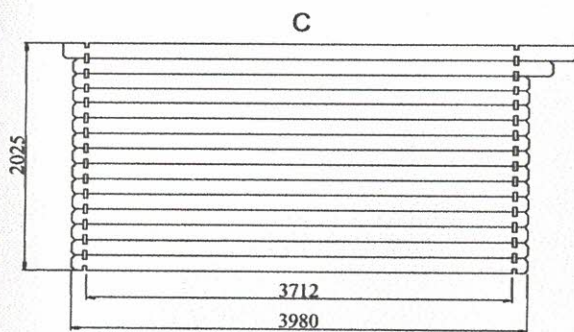
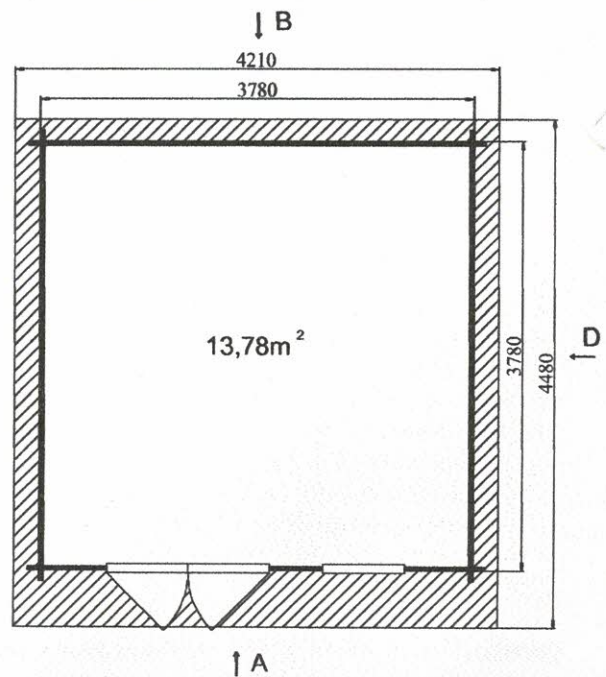
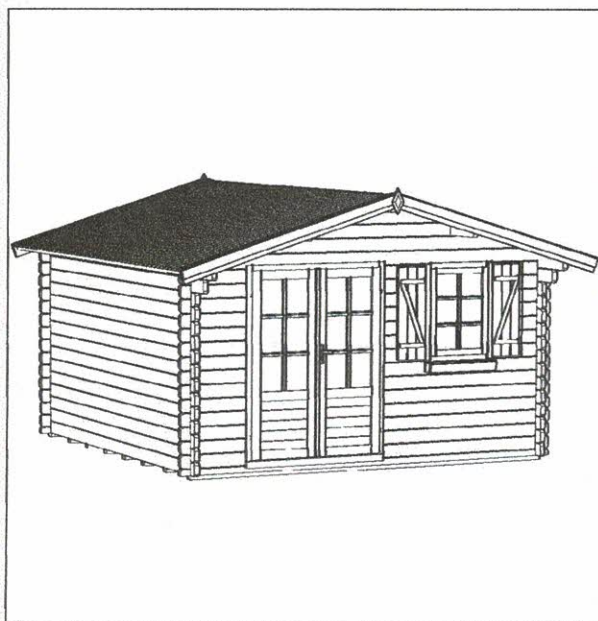
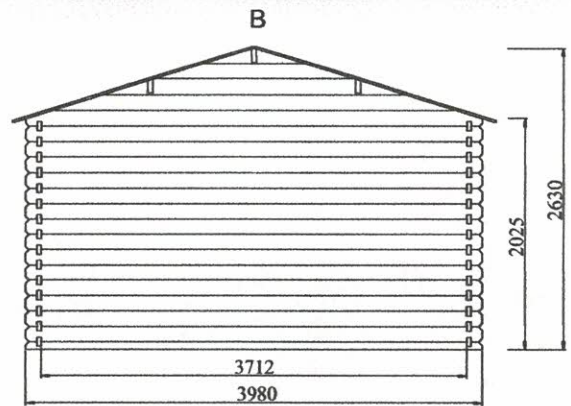
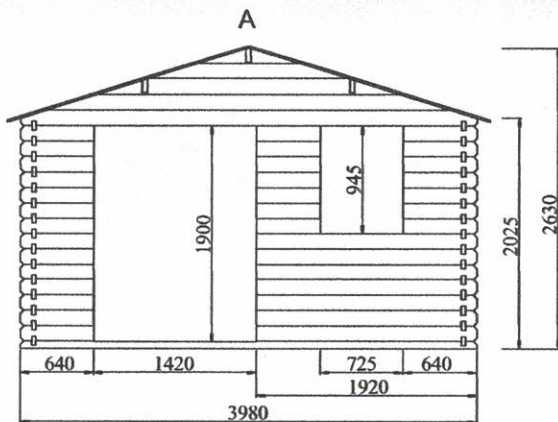

La marque de la
gestion forestière
responsable



Les plus produit:

- Matière - sapin du nord naturel, prêt à traiter;
- Porte menuisère double / semi vitrée / vitrage en verre avec croisillons, poignée et serrure à cylindre, largeur: 1,42 m / hauteur: 1,90 m;
- Fenêtre double / oscillo-battante / vitrage en verre avec croisillons, largeur: 1,36 m / hauteur: 0,94 m. Paire de volets et jardinière incluse;
- Seuil de la porte et seuil de la fenêtre anti goutte en aluminium;
- Chaque fenêtre et porte est équipée d'un joint d'isolation;
- Toiture en bois massif 18 mm / couverture de toit en rouleau de toile bitumée (épaisseur 3,6 mm). Toiture à couvrir: 24,2 m²;
- Lisse basse incluse.



CONDITIONEMENT:

Dimensions mini de la dalle en béton: 4,26x3,78 m
Surface à traiter: 90 m²

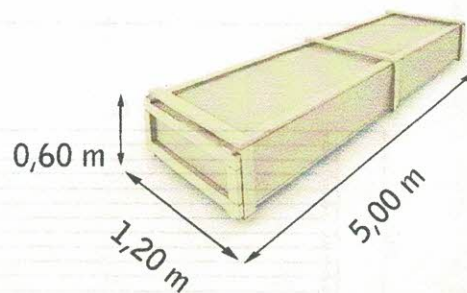
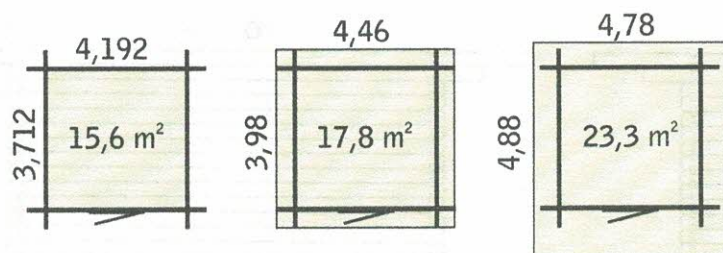

Poids brut: 1140 kg

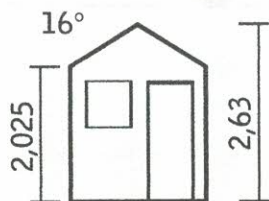

La marque de la gestion forestière responsable



2876 € TTC

ABRI DU JARDIN BOIS KIT
emboité 4,5 x 4,0 m Ep. 34 mm

LILAS 16

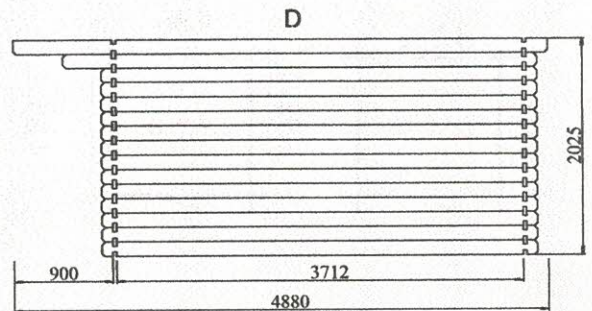
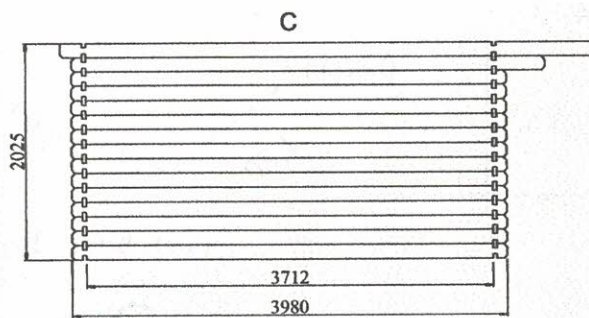
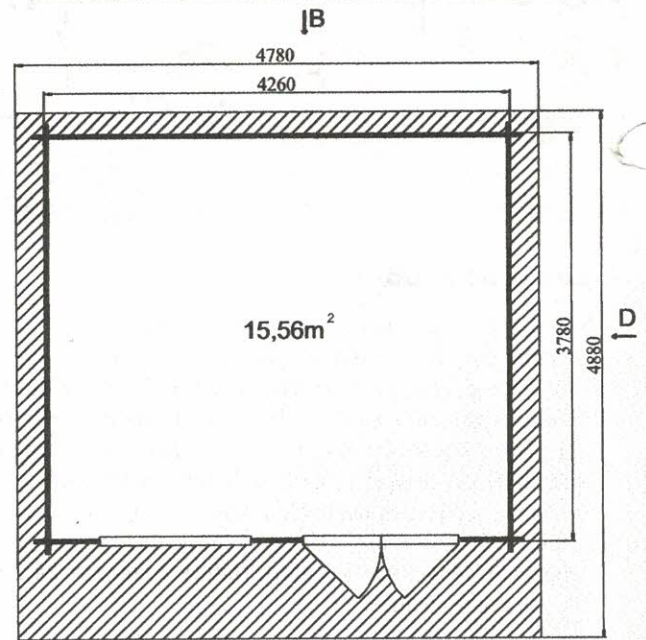
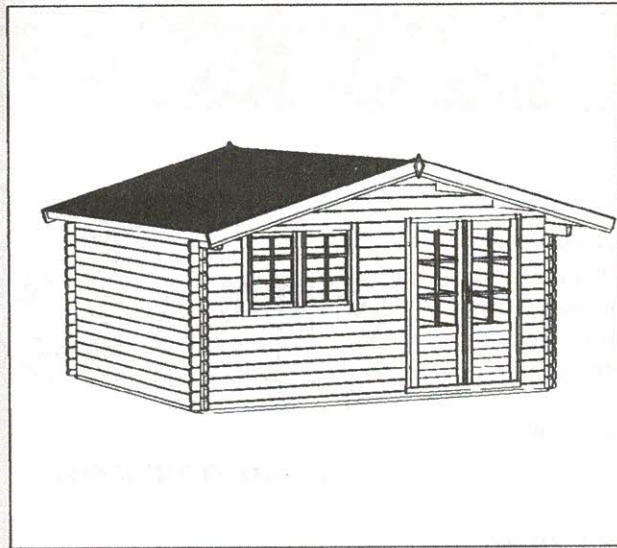
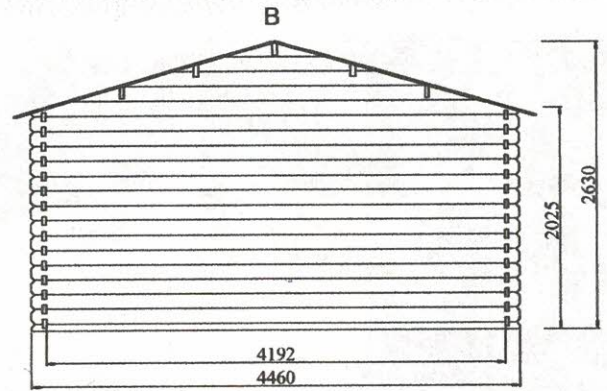
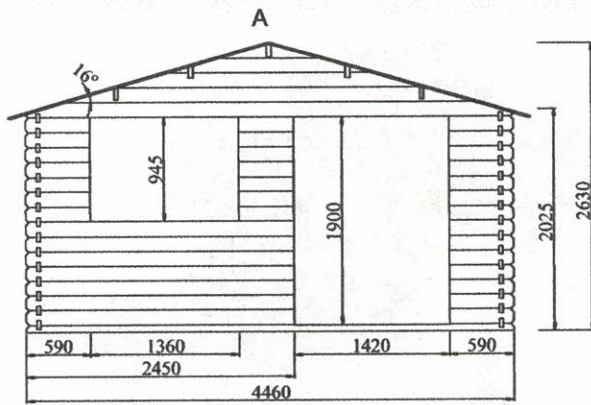

La marque de la
gestion forestière
responsable



Les plus produit:



- Matière - sapin du nord naturel, prêt à traiter;
- Porte menuisère double / semi vitrée / vitrage en verre avec croisillons, poignée et serrure à cylindre, largeur: 1,42 m / hauteur: 1,90 m;
- 2 fenêtres simples / oscillo-battantes / vitrage en verre avec croisillons, largeur: 0,72 m / hauteur: 0,94 m. Paire de volets et jardinières incluses.
- Seuil de la porte et seuils des fenêtres anti goutte en aluminium;
- Chaque fenêtre et porte est équipée d'un joint d'isolation;
- Toiture en bois massif 18 mm / couverture de toit en rouleau de toile bitumée (épaisseur 3,6 mm). Toiture à couvrir: 26,8 m²;
- Lisse basse incluse.

CONDITIONEMENT:

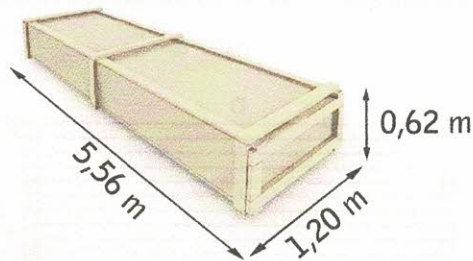

Poids brut: 1260 kg

Dimensions mini de la dalle en béton: 4,78x3,78 m
Surface à traiter: 100 m²

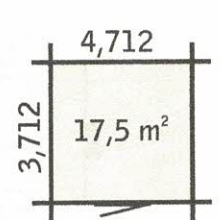
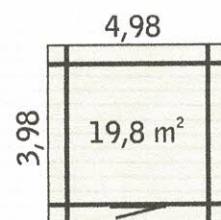
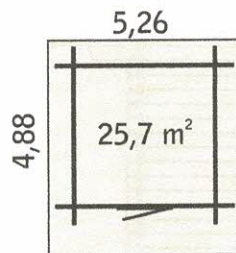

La marque de la
gestion forestière
responsable

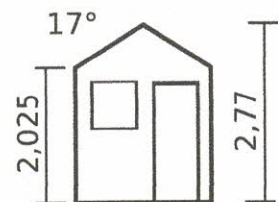

3167 € TTC

ABRI DU JARDIN BOIS KIT
emboîté 5 x 4 m Ep. 34 mm

PAVIER 17

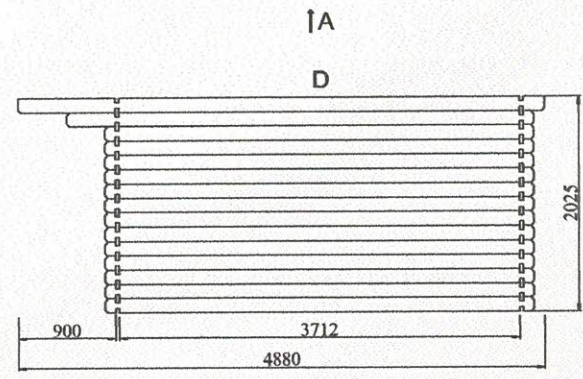
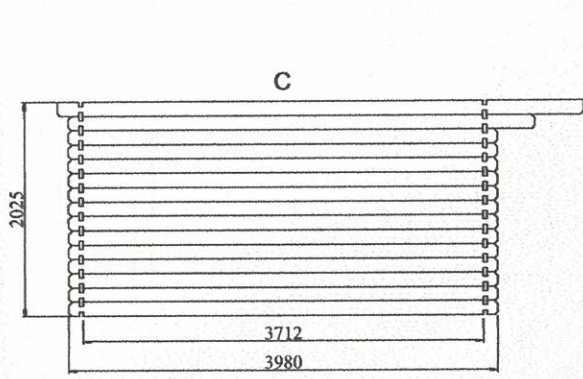
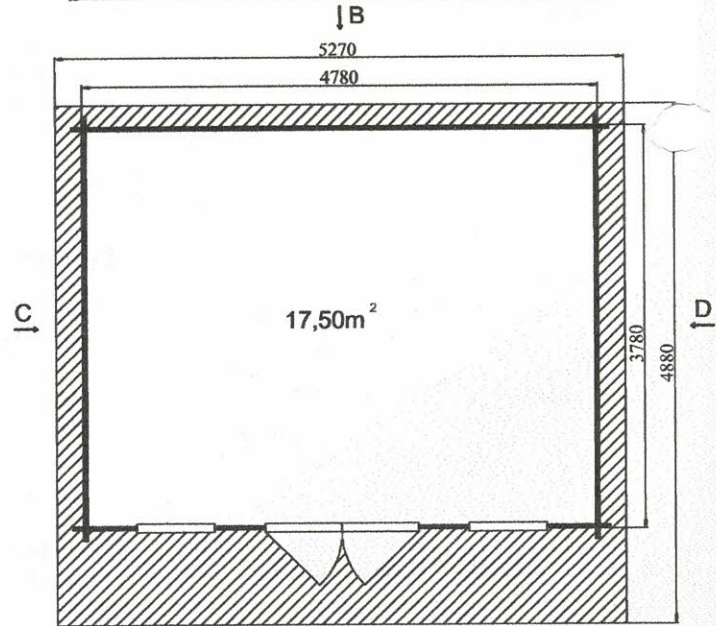
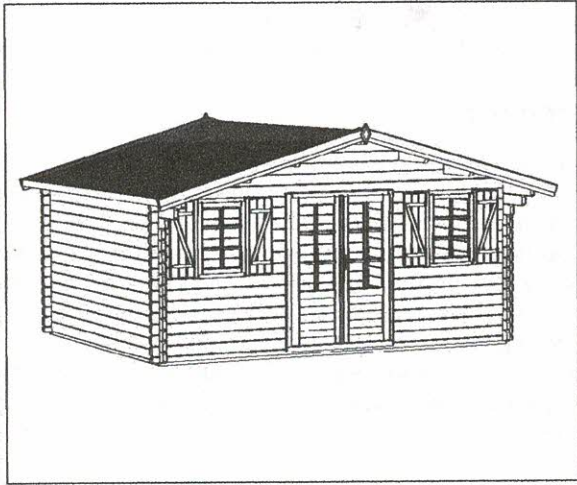
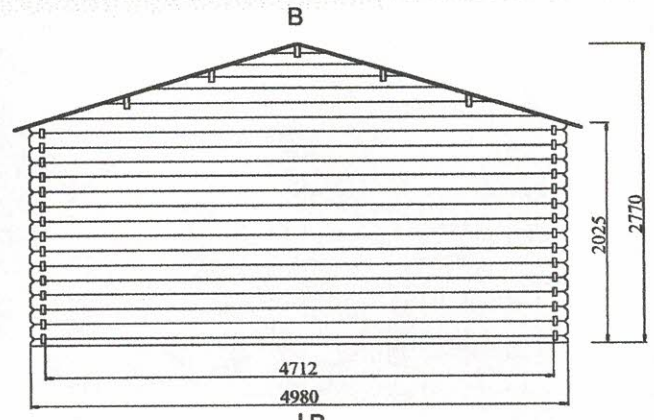
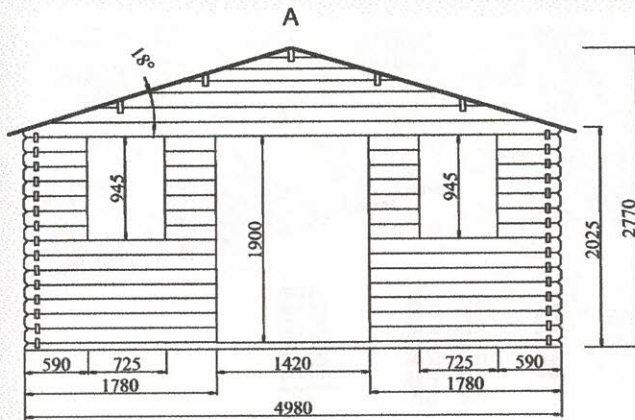

La marque de la
gestion forestière
responsable



Les plus produit:

- Matière - sapin du nord naturel, prêt à traiter;
- Porte menuisère double / semi vitrée / vitrage en verre avec croisillons, poignée et serrure à cylindre, largeur: 1,42 m / hauteur: 1,90 m;
- 1 fenêtre simple, 1 fenêtre double / oscillo-battantes / vitrage en verre 4mm, largeur: 0,72 m - 1,36 m / hauteur: 0,94 m;
- Paire de volets et jardinières incluses;
- Seuil de la porte et seuils des fenêtres anti goutte en aluminium;
- Chaque fenêtre et porte est équipée d'un joint d'isolation;
- Toiture en bois massif 18 mm / couverture de toit en bardeaux bitumineux (shingle roof). Toiture à couvrir: 24,1 m²;
- Solives traitées et plancher inclus.



Dimensions mini de la dalle en béton: 4,78x3,78 m
Surface à traiter: 115 m²

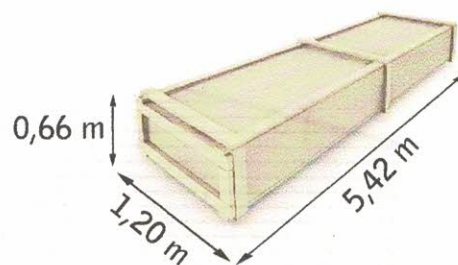
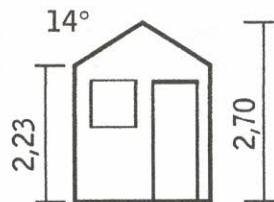
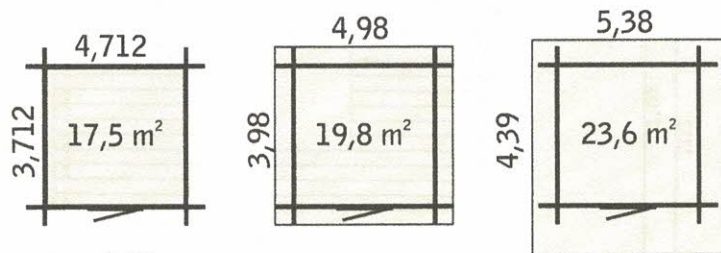

Poids brut: 1560 kg



La marque de la gestion forestière responsable



3866 € TTC

ABRI DU JARDIN BOIS KIT
emboité 5 x 4 m Ep. 34 mm

GOUMI 18

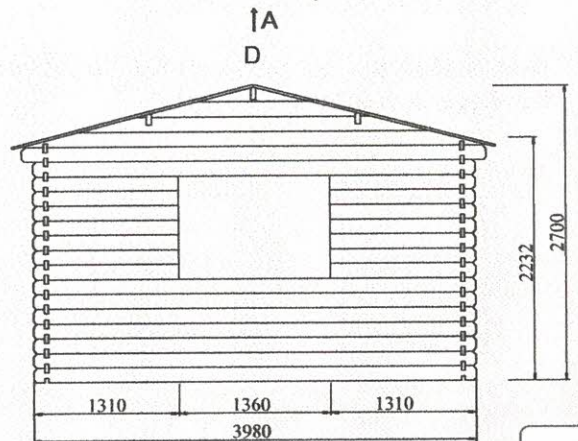
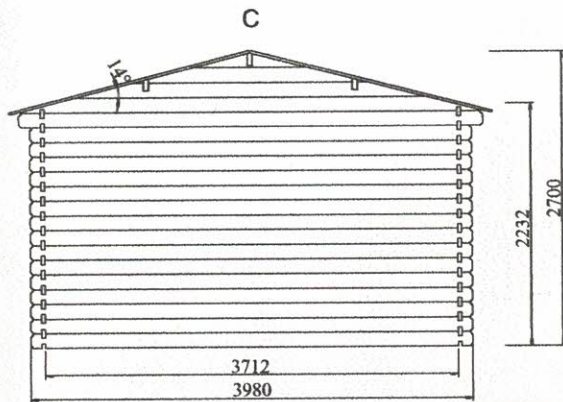
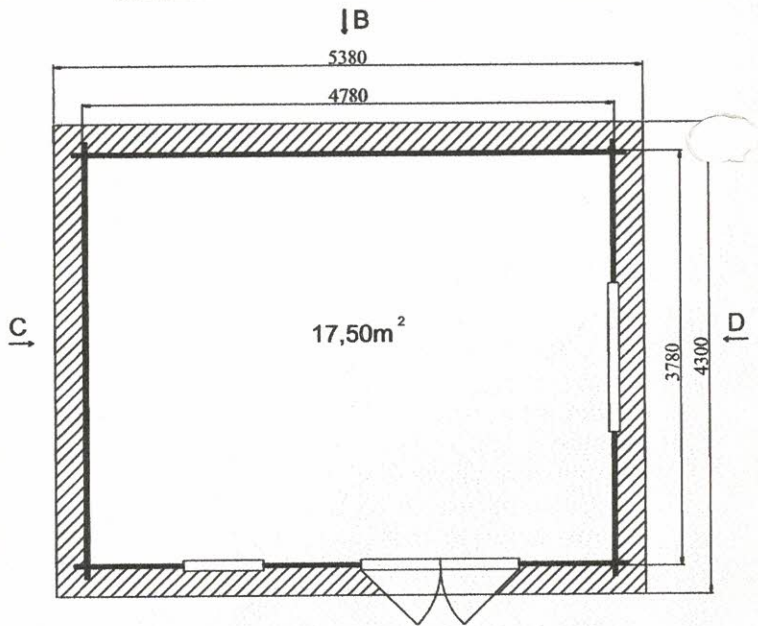
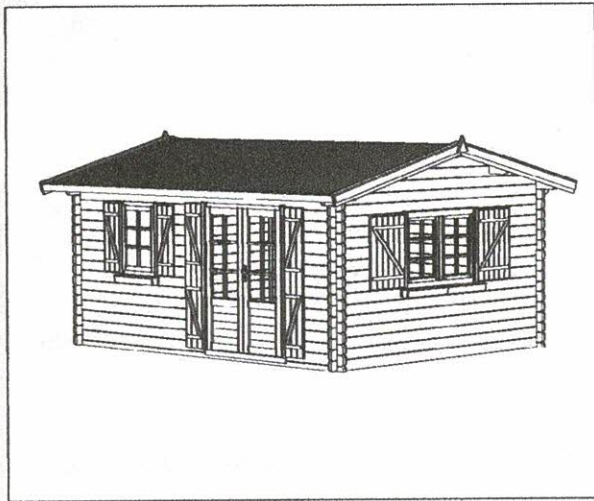
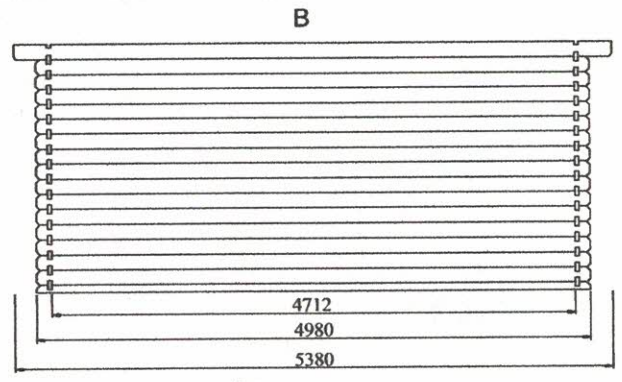
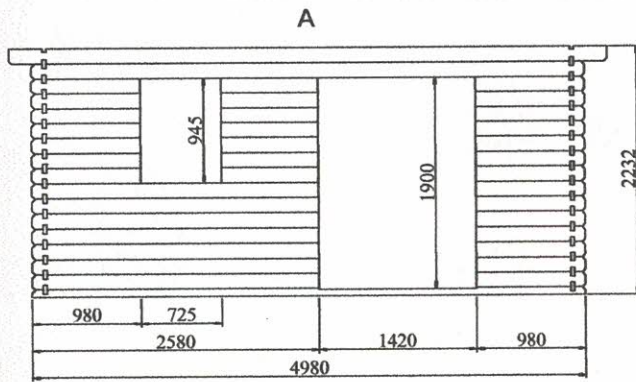

La marque de la
gestion forestière
responsable