



SOLAR

ALUMERO

EN

LANDSCAPE 2.1



# LANDSCAPE 2.1

## GROUND MOUNTING SYSTEM

With a clever mix of high-quality steel components and innovative aluminum components our ALUMERO ground mounting system **LANDSCAPE 2.1** can optimal respond to your requirements. Ease installation is also of paramount importance for ground mounting system as in the entire portfolio of ALUMERO. With the pre-assembled components for quick mounting you can achieve maximum installation speed. Due to sophisticated standard components different table configurations can be realized immediately from stock. In addition, the simple adjustability makes it easy to adapt the table configuration at site to the different terrain. Thereby your solar park fits in every case, even in difficult terrain.

### YOUR BIG ADVANTAGE

- + optimized adaptation to the relief by integrated adjustment
- + effective utilization of material
- + quick and easy installation
- + small quantity of individual components
- + project-related planning and structural calculation
- + no sealing of the soil
- + long life time by high quality components
- + corrosion-resistant
- + easy maintenance of terrain and pasturing possible
- + complete recyclable
- + high residual value



LANDSCAPE 2.1



Clamps as pre-assembled components



Aluminium mounting profiles, varying to the wind- and snowloads

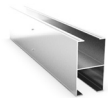

Profile connector with slipping protection

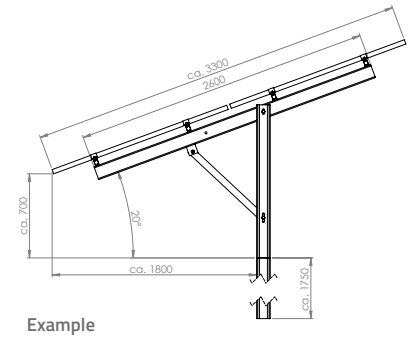
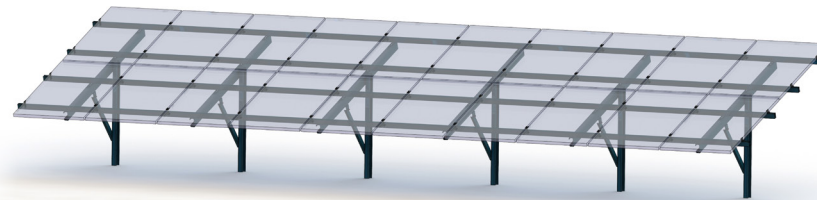
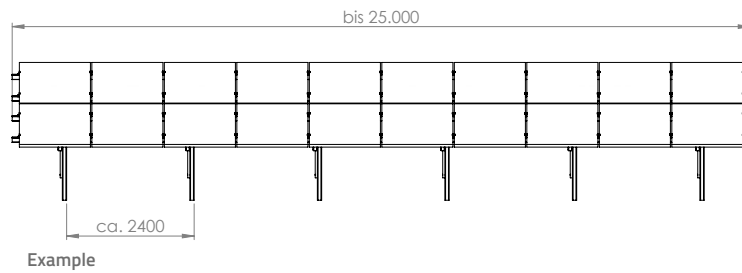

## TECHNICAL SPECIFICATIONS

Table design:	<b>2 module in portrait in top of each other</b>
Table inclination:	<b>19° - 35°</b>
Table length:	<b>up to 25 m</b>
Depth of penetration:	<b>Standard 1750mm or rather to custom specification</b>
Height of bottom edge of table:	<b>variable</b>
Distance of piles and rafters:	<b>will be calculated project-related and is depending on the local wind and snow load assumptions</b>
Cross section profiles:	<b>will be calculated project-related and is depending on the local wind and snow load assumptions</b>
Material of piles and rafters:	<b>galvanized steel</b>
Material of mounting profiles and clamps:	<b>aluminium EN AW 6063 T66</b>
Material of fastening elements:	<b>Stainless steel A2-70</b>
Accessory:	<b>earthing clamp for potential equalization, components for cable fixation, components for internal potential equalization, ground wire, clamps for all types of modules</b>

profiles

artikel-nr: 16759  
product-nr: 802102-62

**Mounting profile 65**  
L=6.200 (-0/+10) mm  
Outside dimensions: 40 x 65 mm  
1x Mounting channel for threaded plate M8  
1x Mounting channel for hammer head screw M8 or M10

drawing number: 802102-62 A  
surface: mill finish

material: EN AW 6063 / T66  
weight: 1,216 kg/mtr  
packaging: 465 mtr. (75 Stg.)  
Wx, Wy: 7795 mm<sup>3</sup>, 3922 mm<sup>3</sup>

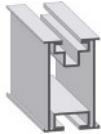

artikel-nr: 16440  
product-nr: 802102Z

**Mounting profile 65 cut**  
L=variabel (-0/+10) mm  
Outside dimensions: 40x65mm  
1 x Mounting channel for threaded plate M8  
1 x Mounting channel for hammer head screw M8 or M10

drawing number: 802102Z A  
surface: mill finish

material: EN AW 6063 / T66  
weight: 1,216 kg/mtr  
packaging:  
Wx, Wy: 7795 mm<sup>3</sup>, 3922 mm<sup>3</sup>



artikel-nr: 16760  
product-nr: 802103-62

**Mounting profile 95**  
L=6.200 (-0/+10) mm  
Outside dimensions: 62 x 95 mm  
1x Mounting channel for threaded plate M8  
1x Mounting channel for hammer head screw M8 or M10

drawing number: 802103-62 A  
surface: mill finish

material: EN AW 6063 / T66  
weight: 1,655 kg/mtr  
packaging: \*223,2 mtr. (36 Stg.)  
Wx, Wy: 16700 mm<sup>3</sup>, 9830 mm<sup>3</sup>



**profiles**

artikel-nr: 16445  
product-nr: 802103Z

**Mounting profile 95 cut**  
L=variabel mm (-0/+10mm)  
Outside dimensions: 62 x 95 mm  
1x Mounting Channel for threaded plate M8  
1x Mounting Channel for hammer head screw M8 or M10

drawing number: 802103Z A  
surface: mill finish

material: EN AW 6063 / T66  
weight: 1,655 kg/mtr  
packaging: 16700 mm<sup>3</sup>, 9830 mm<sup>3</sup>  
Wx, Wy:



artikel-nr: 17112  
product-nr: 802104-62

**Mounting profile 80**  
L=6.200 (-0/+10) mm  
Outside dimensions: 50 x 80 mm  
1x Mounting channel for threaded plate M8  
1x Mounting channel for hammer head screw M8 or M10

drawing number: 802104-62 A  
surface: mill finish

material: EN AW 6063 / T66  
weight: 1,437 kg/mtr  
packaging: \*341 mtr. (55 Stg.)  
11797 mm<sup>3</sup>, 5943 mm<sup>3</sup>  
Wx, Wy:



artikel-nr: 17114  
product-nr: 802104Z

**Mounting profile 80**  
L=variabel (-0/+10) mm  
Outside dimensions: 50 x 80 mm  
1x Mounting channel for threaded plate M8  
1x Mounting channel for hammer head screw M8 or M10

drawing number: 802104Z A  
surface: mill finish

material: EN AW 6063 / T66  
weight: 1,437 kg/mtr  
packaging: 11797 mm<sup>3</sup>, 5943 mm<sup>3</sup>  
Wx, Wy:



**connection parts**

artikel-nr: 16441  
product-nr: 802152

**Profile connector 65**  
L=400mm  
for Mounting profile 65  
Outside dimensions: 30 x 3 x 8,3 mm

drawing number: 802152 B  
material: EN AW 6063 / T66  
weight: 0,220 kg/Stk  
packaging: 10 Stk. pro Karton / 1.000 Stk. pro Palette



artikel-nr: 17418  
product-nr: 802152S

**Profile connector 65 S**  
L=400mm  
for Mounting profile 65 incl. 4 self drilling screws SW8 6,0 x 25 mm  
Outside dimensions: 30 x 3 x 8,3 mm

drawing number: 802152S B  
material: EN AW 6063 / T66  
weight: 0,248 kg/Stk  
packaging: \*10 Stk. pro Karton / 1.000 Stk. pro Palette

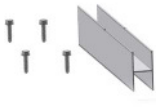

artikel-nr: 16446  
product-nr: 802153

**Profile connector 95**  
L=400mm  
for Mounting profile 95  
Outside dimension: 51,1 x 91,3 mm

drawing number: 802153 B  
material: EN AW 6063 / T66  
weight: 0,453 kg/Stk  
packaging: \*10 Stk. pro Karton/240 Stk. pro Palette

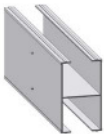

artikel-nr: 17419  
product-nr: 802153S

**Profile connector 95 S**  
L=400mm  
for Mounting profile 95 incl 4 pcs. self drilling screws SW8 6,0 x 25  
Outside dimension: 51,1 x 91,3 mm

drawing number: 802153S B  
material: EN AW 6063 / T66  
weight: 0,481 kg/Stk  
packaging: \*10 Stk. pro Karton / 240 Stk. pro Palette

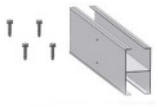

**connection parts**

artikel-nr: 17115  
product-nr: 802154

**Profile connector 80**  
L=400mm  
for Mounting profile 80  
Outside dimension: 39,1 x 76,3 mm

drawing number: 802154 A  
material: EN AW 6063 / T66  
weight: 0,345 kg/Stk  
packaging: \*10 Stk. pro Karton / 240 Stk. pro Palette



artikel-nr: 18061  
product-nr: 802154S

**Profile connector 80 S**  
L=400mm  
for Mounting profile 80 incl. 4 self drilling screws SW10 6,3 x 25 mm  
Outside dimensions: 30 x 3 x 58,3 mm

drawing number: 802154S A  
material: EN AW 6063 / T66  
weight: 0,345 kg/Stk  
packaging: \*10 Stk. pro Karton / 240 Stk. pro Palette

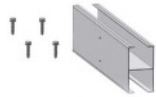

**clamps**

artikel-nr: 19161  
product-nr: 800301P

**Earthing plate for Middle clamp**  
L=66 mm; B= 35 mm  
to implement the Modules in the grounding  
For Middle clamps with L= 50 mm and W= 20 mm

drawing number: 800301P B  
surface: stainless steel 1.4301  
material: Edelstahl 1.4301  
weight: 0,300 kg/100 Stk.  
packaging: 100 Stk. pro PE Beutel; 4.200 Stk. pro Karton



artikel-nr: 16482  
product-nr: 802301-31V

**Middle clamp for fast mounting 30-33**  
L=50mm  
Incl. Opening-function  
for Frame height 31-33 mm  
for Mounting profiles with threaded plate channel M8

drawing number: 802301-31V A  
surface: mill finish; stainless steel A2-70  
material: EN AW 6063 / T66; A2-70  
weight: 0,046 kg/Stk  
packaging: 50 Stk. pro Karton / 4.950 Stk. pro Palette



**clamps**

artikel-nr: 15782  
product-nr: 802301-34V

**Middle clamp for fast mounting 34-38**  
L=50mm  
incl. Opening-function  
for Frame height 31-33 mm  
for Mounting profile with threaded plate channel M8

drawing number: 802301-34V A  
surface: mill finish; stainless steel A2-70

material: EN AW 6063 / T66; A2-70  
weight: 0,048 kg/Stk  
packaging: 50 Stk. pro Karton / 4.950 Stk. pro Palette



artikel-nr: 15783  
product-nr: 802301-40V

**Middle clamp for fast mounting 40-43**  
L=50mm  
incl. Opening-function  
for Frame height 40-43 mm  
for Mounting profile with threaded plate channel M8

drawing number: 802301-40V A  
surface: mill finish; stainless steel A2-70

material: EN AW 6063 / T66; A2-70  
weight: 0,050 kg/Stk  
packaging: 50 Stk. pro Karton / 4.950 Stk. pro Palette



artikel-nr: 15784  
product-nr: 802301-45V

**Middle clamp for fast mounting 45-46**  
L=50mm  
Incl. Opening-function  
for Frame height 45-46 mm  
for Mounting profiles with threaded plate channel M8

drawing number: 802301-45V A  
surface: mill finish; stainless steel A2-70

material: EN AW 6063 / T66; A2-70  
weight: 0,052 kg/Stk  
packaging: \*50 Stk. pro Karton / 4.950 Stk. pro Palette



artikel-nr: 15785  
product-nr: 802301-50V

**Middle clamp for fast mounting 47-50**  
L=50mm  
Incl. Opening-function  
for Frame height 47-50 mm  
for Mounting profiles with threaded plate channel M8

drawing number: 802301-50V A  
surface: mill finish; stainless steel A2-70

material: EN AW 6063 / T66; A2-70  
weight: 0,054 kg/Stk  
packaging: \*50 Stk. pro Karton / 4.950 Stk. pro Palette





**clamps**

artikel-nr: 17046  
product-nr: 802301C

**Middle clamp Click 2.1**  
L=50mm  
inkl. Opening-function  
for Frame height 35-50 mm  
for mounting profile with threaded plate channel M8

drawing number: 802301C A  
surface: mill finish;stainless steel A2-70

material: EN AW 6063 / T66; A2-70  
weight: 0,058 kg/Stk  
packaging: 50 Stk. pro Karton / 4.950 Stk. pro Palette



artikel-nr: 17753  
product-nr: 802304-30V

**End clamp for fast mounting 30**  
L=50mm  
Incl. Opening-function  
for Frame height 30 mm  
for Mounting profiles with threaded plate channel M8

drawing number: 802304-30V A  
surface: mill finish

material: EN AW 6063 / T66; A2-70  
weight: 0,046 kg/Stk  
packaging: \*20 Stk. pro Karton / 7.000 Stk. pro Palette



artikel-nr: 16481  
product-nr: 802304-31V

**End clamp for fast mounting 31**  
L=50mm  
Incl. Opening-function  
for Frame height 31 mm  
for Mounting profiles with threaded plate channel M8

drawing number: 802304-31V B  
surface: mill finish

material: EN AW 6063 / T66; A2-70  
weight: 0,046 kg/Stk  
packaging: \*20 Stk. pro Karton / 7.000 Stk. pro Palette



artikel-nr: 18079  
product-nr: 802304-33V

**End clamp for fast mounting 33**  
L=50mm  
Incl. Opening-function  
for Frame height 33 mm  
for Mounting profiles with threaded plate channel M8

drawing number: 802304-33V A  
surface: mill finish

material: EN AW 6063 / T66; A2-70  
weight: 0,048 kg/Stk  
packaging: \*20 Stk. pro Karton / 7.000 Stk. pro Palette



**clamps**

artikel-nr: 15786  
product-nr: 802304-34V

**End clamp for fast mounting 34**  
L=50mm  
Incl. Opening-function  
for Frame height 34 mm  
for Mounting profiles with threaded plate channel M8

drawing number: 802304-34V B  
surface: mill finish

material: EN AW 6063 / T66; A2-70  
weight: 0,048 kg/Stk  
packaging: \*20 Stk. pro Karton / 7.000 Stk. pro Palette



artikel-nr: 15787  
product-nr: 802304-35V

**End clamp for fast mounting 35**  
L=50mm  
Incl. Opening-function  
for Frame height 35 mm  
for Mounting profiles with threaded plate channel M8

drawing number: 802304-35V B  
surface: mill finish

material: EN AW 6063 / T66; A2-70  
weight: 0,048 kg/Stk  
packaging: 20 Stk. pro Karton / 7.000 Stk. pro Palette



artikel-nr: 15789  
product-nr: 802304-36V

**End clamp for fast mounting 36**  
L=50mm  
Incl. Opening-function  
for Frame height 36 mm  
for Mounting profiles with threaded plate channel M8

drawing number: 802304-36V B  
surface: mill finish

material: EN AW 6063 / T66; A2-70  
weight: 0,049 kg/Stk  
packaging: \*20 Stk. pro Karton / 7.000 Stk. pro Palette



artikel-nr: 15790  
product-nr: 802304-38V

**End clamp for fast mounting 38**  
L=50mm  
Incl. Opening-function  
for Frame height 38 mm  
for Mounting profiles with threaded plate channel M8

drawing number: 802304-38V B  
surface: mill finish

material: EN AW 6063 / T66; A2-70  
weight: 0,050 kg/Stk  
packaging: 20 Stk. pro Karton / 7.000 Stk. pro Palette



**clamps**

artikel-nr: 15791  
product-nr: 802304-40V

**End clamp for fast mounting 40**  
L=50mm  
Incl. Opening-function  
for Frame height 40 mm  
for Mounting profiles with threaded plate channel M8

drawing number: 802304-40V B  
surface: mill finish

material: EN AW 6063 / T66; A2-70  
weight: 0,051 kg/Stk  
packaging: 20 Stk. pro Karton / 7.000 Stk. pro Palette



artikel-nr: 15792  
product-nr: 802304-42V

**End clamp for fast mounting 42**  
L=50mm  
Incl. Opening-function  
for Frame height 42 mm  
for Mounting profiles with threaded plate channel M8

drawing number: 802304-42V B  
surface: mill finish

material: EN AW 6063 / T66; A2-70  
weight: 0,051 kg/Stk  
packaging: \*20 Stk. pro Karton / 7.000 Stk. pro Palette



artikel-nr: 15793  
product-nr: 802304-43V

**End clamp for fast mounting 43**  
L=50mm  
Incl. Opening-function  
for Frame height 43 mm  
for Mounting profiles with threaded plate channel M8

drawing number: 802304-43V B  
surface: mill finish

material: EN AW 6063 / T66; A2-70  
weight: 0,052 kg/Stk  
packaging: \*20 Stk. pro Karton / 7.000 Stk. pro Palette



artikel-nr: 15795  
product-nr: 802304-45V

**End clamp for fast mounting 45**  
L=50mm  
Incl. Opening-function  
for Frame height 45 mm  
for Mounting profiles with threaded plate channel M8

drawing number: 802304-45V B  
surface: mill finish

material: EN AW 6063 / T66; A2-70  
weight: 0,052 kg/Stk  
packaging: \*20 Stk. pro Karton / 7.000 Stk. pro Palette



**clamps**

artikel-nr: 15794  
product-nr: 802304-46V

**End clamp for fast mounting 46**  
L=50mm  
Incl. Opening-function  
for Frame height 46 mm  
for Mounting profiles with threaded plate channel M8

drawing number: 802304-46V B  
surface: mill finish

material: EN AW 6063 / T66; A2-70  
weight: 0,053 kg/Stk  
packaging: 20 Stk. pro Karton / 7.000 Stk. pro Palette



artikel-nr: 15797  
product-nr: 802304-50V

**End clamp for fast mounting 50**  
L=50mm  
Incl. Opening-function  
for Frame height 50 mm  
for Mounting profiles with threaded plate channel M8

drawing number: 802304-50V B  
surface: mill finish

material: EN AW 6063 / T66; A2-70  
weight: 0,054 kg/Stk  
packaging: \*20 Stk. pro Karton / 7.000 Stk. pro Palette



**standard parts/accessories**

artikel-nr: 14730  
product-nr: 800623

**Hexagon screw**  
M10x25  
SW17

drawing number: 800623 DIN 933  
material: A2-70  
weight: 2,370 kg/100 Stk.  
packaging: 100 Stk.



artikel-nr: 15325  
product-nr: 800626

**Hexagon screw**  
M16x35  
SW24

drawing number: 800626 DIN 933  
material: A2-70  
weight: 8,350 kg/100 Stk.  
packaging: 50 Stk.



**standard parts/accessories**

artikel-nr: 15052  
product-nr: 800634

**Hexagon nut**  
M10  
with flange and serration

drawing number: 800634 DIN 6923  
material: A2-70  
weight: 1,120 kg/100 Stk.  
packaging: 100 Stk.



artikel-nr: 15591  
product-nr: 800636

**Hexagon nut**  
M16  
with flange and serration

drawing number: 800636 DIN 6923 B  
material: A2-70  
weight: 5,000 kg/100 Stk.  
packaging: 50



artikel-nr: 15453  
product-nr: 800646

**Hammerhead screw**  
M10x25

drawing number: 800646  
material: A2-70  
weight: 1,990 kg/100 Stk.  
packaging: 100 Stk.



artikel-nr: 16699  
product-nr: 800654

**Flat washer**  
A17

drawing number: 800654 DIN125  
material: A2-70  
weight: 1,014 kg/100 Stk.  
packaging: 100 Stk.



**landscape 2.1**

artikel-nr: 17683  
product-nr: 800762-355

**Strut Landscape**  
L=900  
from angle profile 60x30x5

drawing number: 800762-355 C  
surface: galvanized  
material: Steel S355 JR  
weight: 2,983 kg/Stk  
packaging:



artikel-nr: 17685  
product-nr: 800763-355

**Connecting angle Landscape**  
L=80 mm  
from angle profile 80x65x6

drawing number: 800763-355 C  
surface: galvanized  
material: Steel S355 JR  
weight: 0,500 kg/Stk  
packaging:



artikel-nr: 17038  
product-nr: 800764

**Seperation TP65-95**  
60x80x1,5  
For Mounting profiles 65 - 95 with elongated hole

drawing number: 800764 D  
material: EPDM  
weight: 0,010 kg/Stk  
packaging:



artikel-nr: 17335  
product-nr: 800765-355

**Post Landscape C-130**  
L=3.200 mm

drawing number: 800765-355 C  
surface: galvanized  
material: Steel S355 JR  
weight: 7,250 kg/mtr  
packaging:



**landscape 2.1**

artikel-nr: 17681  
product-nr: 800766-355

**Beam Landscape C-120/3**  
L=2.600mm  
For inclination angle from 18 - 35°

drawing number: 800766-355 C  
surface: galvanized  
material: Steel S355 JR  
weight: 6,000 kg/mtr  
packaging:



**NOTES**

---

---

---

---

---

---

---

---

---

---

---

---

---

---

---

---

---

---

---

---

---

---

---

---

---

---

# ALUMERO GROUP

## DESIGN, DEVELOPMENT, CONSTRUCTION UND PRODUCTION

ALUMERO creates long-term solutions based on innovative ideas. We apply our comprehensive knowledge of products and production methods to all aspects of design and development. This enables us to offer cost-optimized product planning resulting in well-thought-out, functional design solutions and an economical and efficient use of equipment.



ALIVE WITH ALUMINIUM

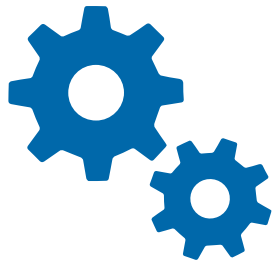

EXTRUSIONS / PROCESSING

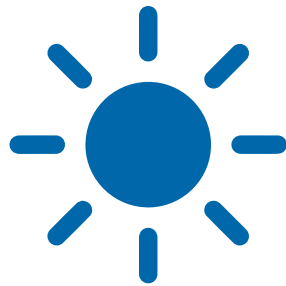

SOLAR



LIVING / INDUSTRY

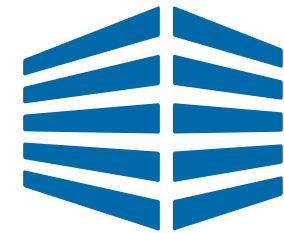

BAUTEC / BMA

## QUALITY

Quality is no coincidence. it a result of all the details that make a product so valuable, functional, technical, and make its shape pleasing to the eye.

- + modern quality management acc. to EN-ISO 9001:2008 standards
- + high-quality delivered products guarantee our success
- + trained RAL quality inspectors

- + customer-oriented quality agreements
- + quality Management as an active and dynamic process
- + TQM, from planning to purchasing to shipping
- + standard quality requirements for welding according to EN-ISO 3834-2
- + production of load-bearing structures according to EN 1090



WWW.ALUMERO.AT



## ALUMERO PRODUCTIONS

Our production facilities provide cost-effective product planning, consistently high product quality and reliable delivery schedules.



**ALUMERO Finex Extrusions**  
Helmond, Netherlands



**ALUMERO Systematic Solutions**  
Headquarter, Seeham, Austria



**ALUMERO Metal Components**  
Chorzów, Poland



**ALUMERO Surface Technology**  
Marktredwitz, Germany



**ALUMERO d.o.o.**  
Sl. Bistrica, Slovenia

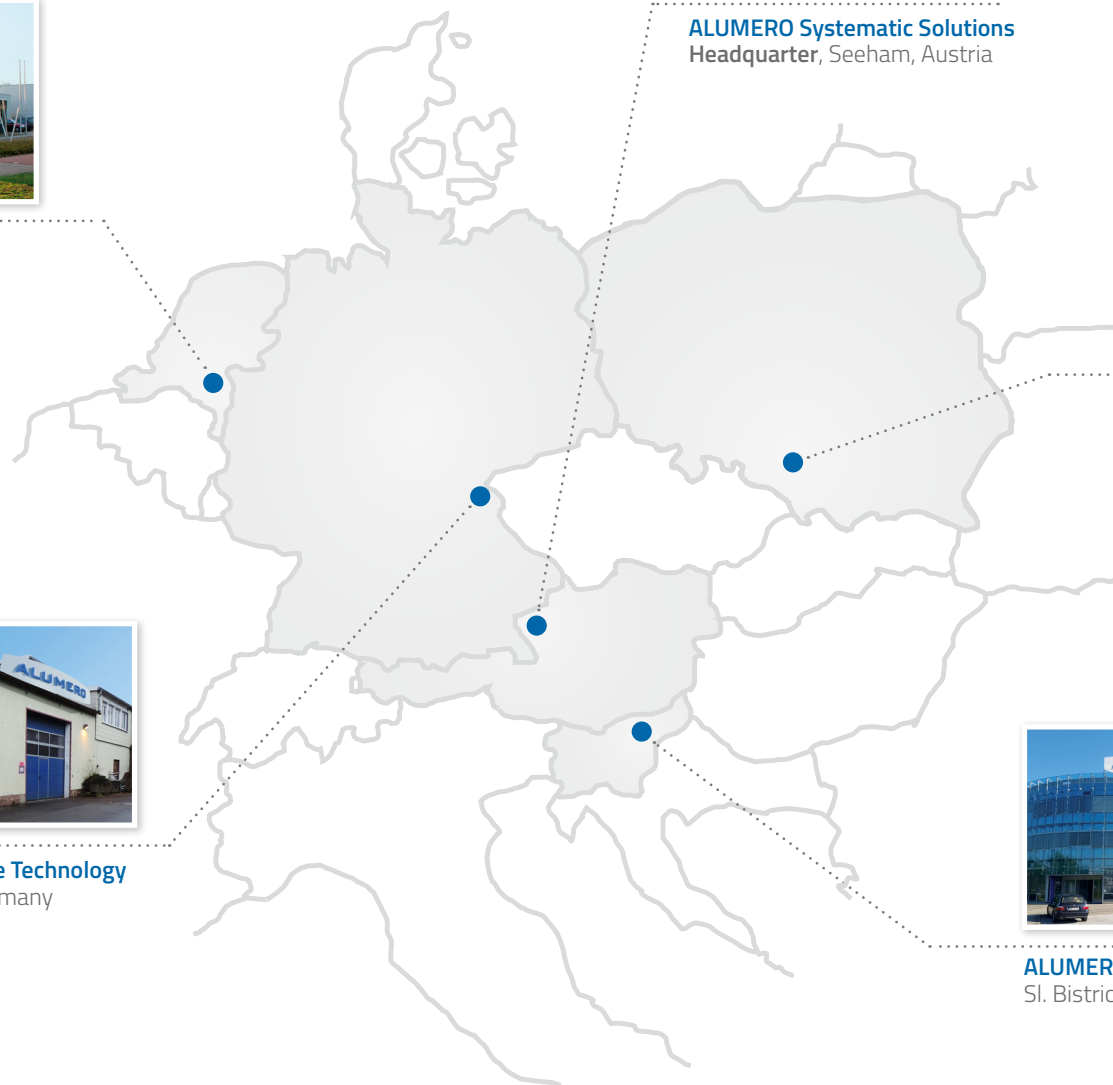

## SEEHAM (AUT)

ALUMERO  
Systematic Solutions GmbH  
Sonnenweg 1-2  
5164 Seeham, Austria

## CHORZOW (PL)

ALUMERO  
Metal Components Sp. z. o.o  
Ul. Kluczborska 29  
41-508 Chorzów, Poland

## HELMOND (NL)

ALUMERO  
Finex Extrusions B.V.  
Duizeldonksestraat 20  
5705 CA Helmond, Netherlands

## SL. BISTRICA (SL)

ALUMERO  
Metal Components d.o.o.  
Kolodvorska 39  
2310 Sl. Bistrica, Slovenia

## MARKTREDWITZ (GER)

ALUMERO  
Surface Technology  
Gaderstrasse 4  
95615 Marktredwitz, Germany

[WWW.ALUMERO.AT](http://WWW.ALUMERO.AT)



## CONTACT HEADQUARTER

ALUMERO Systematic Solutions GmbH  
Sonnenweg 1-2  
5164 Seeham - Austria  
T +43 6217 / 68 41-0  
F +43 6217 / 68 41-41  
solar@alumero.at  
www.alumero.at

I'M ALWAYS HERE  
WHEN YOU NEED ME.

