

Quality Made in Germany since 1924



Flexible polishing of glass edges with ARTIFEX

Innovative tools with a tradition.

ARTIFEX – Your Partner for Metal and Glass Working



WHAT MAKES US SPECIAL

Founded in 1924 in Hamburg as a medium-sized, family-run company, ARTIFEX soon became popular with its domestic metal cleaning blocks. Today, we are one of the world's leading manufacturers of elastic bonded abrasives. With our global sales network, we advise customers all over the world when it comes to glass and metal working.

ARTIFEX offers you quality "Made in Germany" and a fair price-performance ratio. As specialists in professional glass and metal working, our consulting services cover the most varied industry sectors, ranging from the process industry, steel engineering and machine engineering through to the aerospace industry. Here we can rely on our almost 100 years of tradition paired with state-of-the-art expertise.

HOW WE VIEW OURSELVES

In intense dialogue with our customers, machine manufacturers and application engineers, we face the challenges posed by new products and surfaces, develop the matching technologies and constantly expand our expertise. As a flexible medium-sized company, we are able to develop ideal solutions for our customers in a speedy and uncomplicated manner. In our laboratory, we research the perfect materials and shapes for a vast range of applications.

WHO WE ARE

We are passionate about finding specific solutions for our customers. Some of us have been working together for decades to achieve this. Every team member brings their own individual expert knowledge and focus on applications to the table. That's because it is only through teamwork that we are able to offer

the flexibility and the service our customers appreciate. When talking to our colleagues, you will notice that we offer much more than a classic consultation. We have made it our mission to engage with the needs of our customers with curiosity and expertise, each and every day.

WHAT WE PRODUCE

Our elastic polishing and grinding tools are used in the most varied sectors. In metal working, they finish surfaces ranging from the most delicate surgical instruments through to heavy-duty turbine blades. When it comes to grinding flat glass edges, elastically bonded abrasives ensure unmatched brilliance and enable you to realise facades, furniture or bathroom furnishings at the highest level.

WHAT WE CAN DO FOR YOU

Our focus is on you as a user. Our versatile grinding and polishing tools are designed for the most varied surfaces. Please take a look at our specialist brochure on glass and metal-working. If you cannot find the right application for your requirements here, then please get in touch with us! We will gladly advise you on your premises and find the right, technically mature solution for you!



ARTIFEX – Your Specialist for Glass Working

You have the edges, we take care of the finish. Our elastic bonded abrasives can be applied in almost all sectors of glass edge processing, regardless of whether flat edge, arris, miter, bevels or laminated glass. With over 90 years of experience in tool development and production, we can ensure the highest quality.

We offer a wide range of products for single and double edger machines. We also realise perfect pencils as well as straight edges and possess the ideal tools for working on laminated glass and decoating of Low-E-Glass. You can only achieve the optimum result with tools that are perfectly matched to each other.

ELASTIC – FLEXIBLE – HIGH-PERFORMANCE

Abrasive grain types like silicon carbide, aluminium oxide or garnet are flexibly embedded in elastic materials like polyurethane, rubber or resin. This makes our grinding and polishing disks as soft as a sponge, fine porous or hard, but always elastic. Depending on the application, the specifically matched composition of grain and bond achieves the desired finish.



YOUR REQUIREMENTS – OUR SERIES

Are you looking for the perfect bevelling tool? Do you want to prevent the edges of laminated glass from sticking? Or have you not yet found the perfect tool for decoating Low-E-Glass? For every desired finish, we offer the right abrasive combination, consisting of polishing wheels, a cerium wheel and the matching special wheels for the arris. Select the series from these that meets your requirements:

- for mirror finish
- for the longest service life
- for low tool costs
- for laminated glass
- for edge decoating Low-E-Glass

ARTIFEX tools speed up the production process and increase the operating efficiency in production. And if there is no matching tool for your individual requirements, we will develop it on the highest level of technology in our research department. Our products and developments are just as flexible in application as your requirements are individual.



Our Series

Our material compositions are as individual as your requirements. The ideal composition of polyurethane, resin or rubber with the corresponding grain guarantees the perfect result. Regardless of whether initial equipment, tools with a long service life, economic variants or special glass: you decide what you need, we have the matching series.

THE DURABLE ONE: SERIES AO – Q

Regular aluminium oxide embedded in an extremely durable polyurethane bond ensures outstanding service lives.

Colour: brown

THE SPARKLER: SERIES AO – BQ

A polyurethane bond encloses the regular aluminium oxide resulting in perfect gloss. Guarantees optimum stability in any process position due to the solid backing plate.

Colour: varies according to grain size

THE ECONOMIC ONE: SERIES AO – BJ

A mixture of grinding and polishing abrasives merge to an economic full material cup wheel in a polyurethane bond.

Colour: varies according to grain size

THE VERSATILE ONE: SERIES BK – PR

A balanced mixture of aluminium oxide in a durable polyurethane bond ensures versatile applicability. These full material cup wheels have the optimum price/performance ratio.

Colour: varies according to grain size

THE CLASSIC: SERIES BK – WR

Pumice and aluminium oxide in a special rubber bond produce a good industrial gloss with a proven long service life.

Colour: grey

THE FIRST CHOICE AT BENTELER: SERIES BK – PBR

As an OEM version, these pre-polish cup wheels are used on Benteler machines. Aluminium oxide in a polyurethane bond combines long service life with a good quality polishing result.

Colour: varies according to grain size

THE GLOSS EXPERT: SERIES CE

Brilliantly white cerium oxide with an extremely fine grain is embedded in elastic resin, a rubber or polyurethane bond, depending on the application, for the best gloss possible.

Colour: white

THE EXTRA-SHARP ONE: SERIES EK – S

The perfect choice for arris with diamond pre-grinding: white special fused aluminium oxide in resin bond polishes without negatively changing the arris geometry.

Colour: yellow

THE INEXPENSIVE ONE: SERIES EK – SJ

These full material cup wheels made of special fused aluminium oxide in a polyurethane bond create an appealing arris at an economic price.

Colour: red

THE MULTI-TALENT: SERIES SC – S

One for everything: silicon carbide in a resin bond grinds and polishes arris without diamond pre-grinding.

Colours: green, red

THE LOW-E-GLASS PROS: SERIES T

Decoating requires special effort. This series with garnet, silicon carbide and regular aluminium oxide as abrasive grain decoates the layers on Low-E-Glass without leaving any residue. Abrasive grain type, grain size and the hardness of the polyurethane bond depend on the respective layers.

Colours: brown, grey, green

You didn't find the perfect series for your requirement? Please contact us! In our laboratory, we are constantly developing material compositions for the special needs of our customers.

Our Tool Overview

PRODUCT	GRINDING MATERIALS BONDING	GRAIN	DELIVERY TYPE	APPLICATION	"FEATURE"
AO – Q7	Aluminium oxide Polyurethane	40 60 80	Cup wheels with plate Rings	Bevel	Extremely long service life
AO – Q6	Aluminium oxide Polyurethane	40 60 80 120	Cup wheels with plate Rings	Good gloss	Extremely long service life
AO – Q4	Aluminium oxide Polyurethane	80 120	Cup wheels with plate Rings	Arris	Extremely long service life
AO – UQ5	Aluminium oxide Polyurethane	120 180	Peripheral wheels	CNC	Extremely long service life
AO – BQ7	Aluminium oxide Polyurethane	40 60 80	Full material cup wheels Rings	Bevel	Coloured according to grain size
AO – BQ6	Aluminium oxide Polyurethane	40 60 80 120 180	Cup wheels with plate Rings	Very good gloss	Coloured according to grain size
AO – BQ5	Aluminium oxide Polyurethane	40 60 80	Cup wheels with plate	Very good gloss	OEM Busetti
AO – BJ	Aluminium oxide Polyurethane	40 60 80 120 180	Full material cup wheels Rings	Good gloss	Low tool costs Coloured according to grain size
EK – UJ	White fused aluminium oxide Polyurethane	60 80 120 180	Peripheral wheels	Pencil	Low tool costs Coloured according to grain size
CE – R	Cerium oxide Rubber	Cerium oxide	Cup wheels with plate Rings	For small machines	High gloss
CE – 3	Cerium oxide Resin	Cerium oxide	Cup wheels with plate Rings	Universally applicable	Perfect high gloss
CE – U	Cerium oxide Resin	Cerium oxide	Peripheral wheels	CNC machines	High gloss
CE – 5	Cerium oxide Polyurethane	Cerium oxide	Cup wheels with plate Rings	High gloss	Extremely long service life
CE – J	Cerium oxide Polyurethane	Cerium oxide	Cup wheels with plate Rings	High gloss	Low tool costs
SG – MT	Garnet Polyurethane	100	Peripheral wheels with core mounted point Sleeves	Low-E-Glass decoating	Low tool costs
SG – HT	Garnet Polyurethane	100	Peripheral wheels with core mounted point Sleeves	Low-E-Glass decoating	Manual machines
NK – HT	Aluminium oxide Polyurethane	220	Peripheral wheels with core mounted point Sleeves	Low-E-Glass decoating	Universally applicable
SC – MT	Silicon carbide Polyurethane	80	Peripheral wheels with core mounted point Sleeves	Low-E-Glass decoating	Extremely long service life
SC – HT	Silicon carbide Polyurethane	150	Peripheral wheel swith core mounted point Sleeves	Low-E-Glass decoating	For butterfly test
SK – HT	Silicon carbide, aluminium oxide Polyurethane	120	Peripheral wheels with core mounted point Sleeves	Low-E-Glass decoating	For especially hard coatings Glass with foil
BK – WR1	Pumice, aluminium oxide Rubber	40 60 80 120 180	Cup wheels with plate Peripheral wheels Rings	Industrial gloss	Extremely long service life
BK – PR	Pumice, aluminium oxide Polyurethane	40 60 80 120 180	Full material cup wheels Rings	Universally applicable	Low tool costs Coloured according to grain size
BK – PBR	Pumice, aluminium oxide Polyurethane	40 60 80 120 180	Cup wheels with plate	Good gloss	OEM Benteler
BK – WN1	Pumice, aluminium oxide Rubber	40 60 80 120 180	Cup wheels with plate Peripheral wheels Rings	Industrial gloss	Adequate service life
SC – WS	Silicon carbide Resin	180	Cup wheels with plate	Arris	Without diamond pre-grinding Soft adjustment from SC - HS
SC – HS	Silicon carbide Resin	280 400 600	Cup wheels with plate	Arris	Without diamond pre-grinding
EK – WBS	White fused aluminium oxide Resin	400	Cup wheels with plate	Arris	OEM Benteler
EK – WS	White fused aluminium oxide Resin	400	Cup wheels with plate	Arris	Smooth setting from EK to MS
EK – MS	White fused aluminium oxide Resin	400	Cup wheels with plate	Arris	Universally applicable
EK – SJ	White fused aluminium oxide Polyurethane	120	Full material cup wheels Rings	Arris	Low tool costs

What is What at ARTIFEX

The reason why ARTIFEX tools adapt so well to your individual requirement is that we manufacture them in the most varied material compositions. Polyurethane as a bond module can be ideally combined with grinding and polishing abrasives ranging from aluminium oxide and garnet up to cerium oxide. Specially devel-

oped rubber bonds and high-tech resin ensure flexibility and a long service life.

We have compiled the series terms for you in the table below. And the marking examples of our product codes let you see the abrasive grain type, grain size, hardness and bond at a glance.

ABRASIVE GRAIN	BONDING	PUR Foamed polyurethane	RUBBER Vulcanised rubber bond	RESIN Polyester or epoxy resin
AO – Aluminium oxide and polishing agent		Q, BJ, BQ, UQ		
BK – Aluminium oxide and pumice powder		PR, PBR	N, R	
CE – Cerium oxide		CE – 5, CE – J	CE – R	CE – 3, CE – U
EK – White fused aluminium oxide		SJ, UJ		WBS, WS, MS
NK – Aluminium oxide		T		
SC – Silicon carbide		T		WS, HS
SG – Garnet		T		
SK – Silicon carbide and aluminium oxide		T		

HARDNESS

W / 7: Soft elastic
M / 5 – 6: Medium elastic
H / 4: Hard elastic

GRITS (FEPA)

40 – 150: Coarse
180 – 220: Fine
400 – 800: Very fine

COLOUR CODE

Grain 40: Blue
Grain 60: Green
Grain 80: Red
Grain 120: Yellow
Grain 180: Purple

PRODUCT CODE EXAMPLE 1

BOND: _____
HARDNESS: _____
GRAIN: _____
TYPE OF ABRASIVE GRAIN: _____

ARTICLE: SC 80 M T

PRODUCT CODE EXAMPLE 2

BOND: _____
HARDNESS: _____
GRAIN: _____
TYPE OF ABRASIVE GRAIN: _____

ARTICLE: AO 40 Q 6



Our Range and Types of Deliveries

SHAPE	D DIAMETER	T WIDTH	H BORE	P RECESS	S SHAFT	L LENGTH	E HEIGHT OF BASE
	Min. – max.	Min. – max.	Min. – max.	Min. – max.	Min. – max.	Min. – max.	Min. – max.
Full material cup wheel	75 – 170 mm	25 – 60 mm	9 – 100 mm	60 – 125 mm	–	–	5 – 19 mm
Cup wheel with plate	75 – 170 mm	25 – 60 mm	9 – 100 mm	60 – 125 mm	–	–	5 – 19 mm
Peripheral wheel	20 – 300 mm	6 – 60 mm	6 – 130 mm	–	–	–	–
Sleeve	15 – 30 mm	6 – 12 mm	5 – 30 mm	–	–	–	–
Mounted point	8 – 30 mm	5 – 30 mm	–	–	3 – 8 mm	40 – 120 mm	–

We provide peripheral wheels, cup wheels, rings, sleeves and points as well as the most varied special shapes according to your special requirements. Segmenting of full material cup wheels and cup wheels with plate can be realised just as special cooling bore holes. Please contact us!

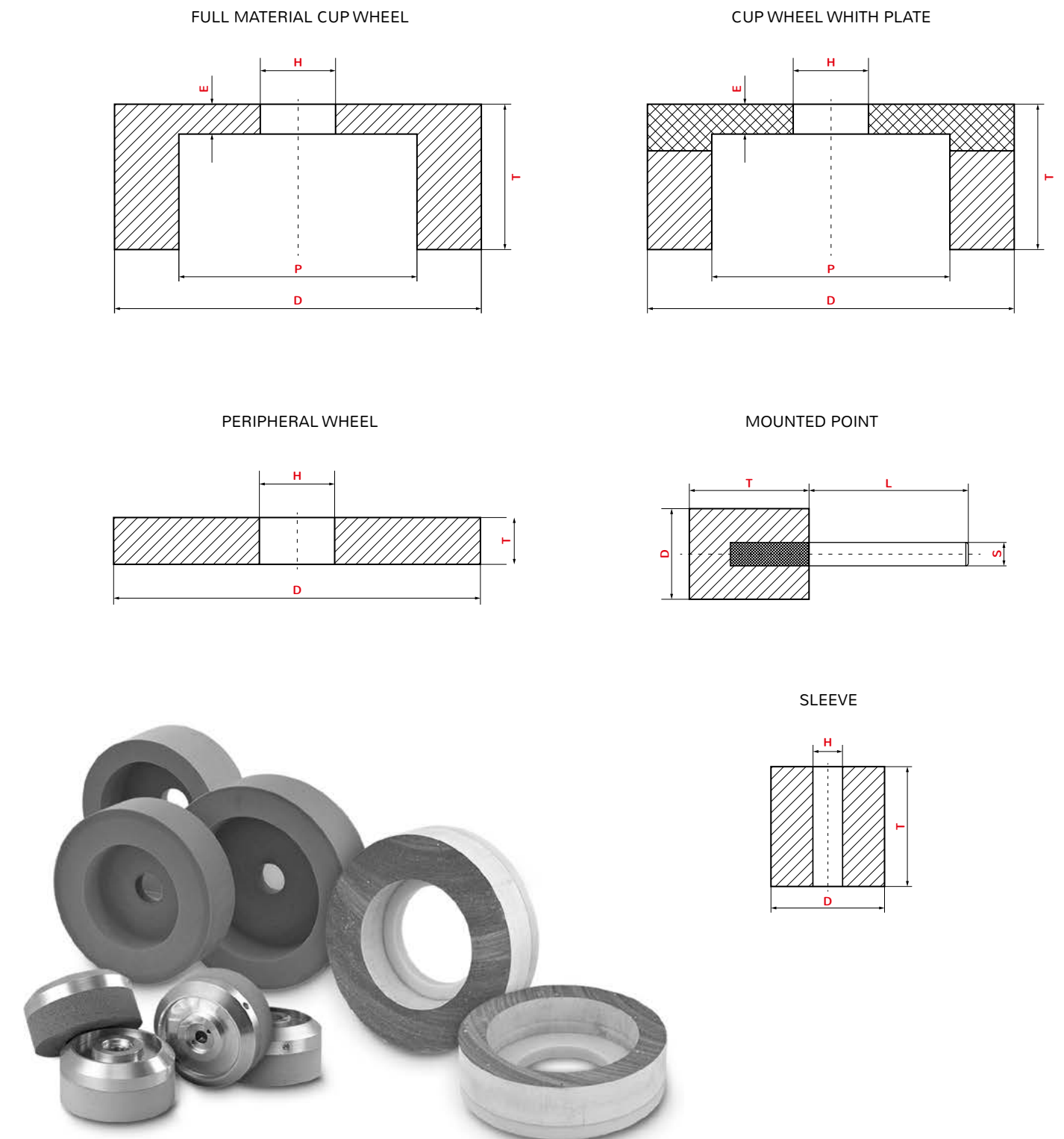
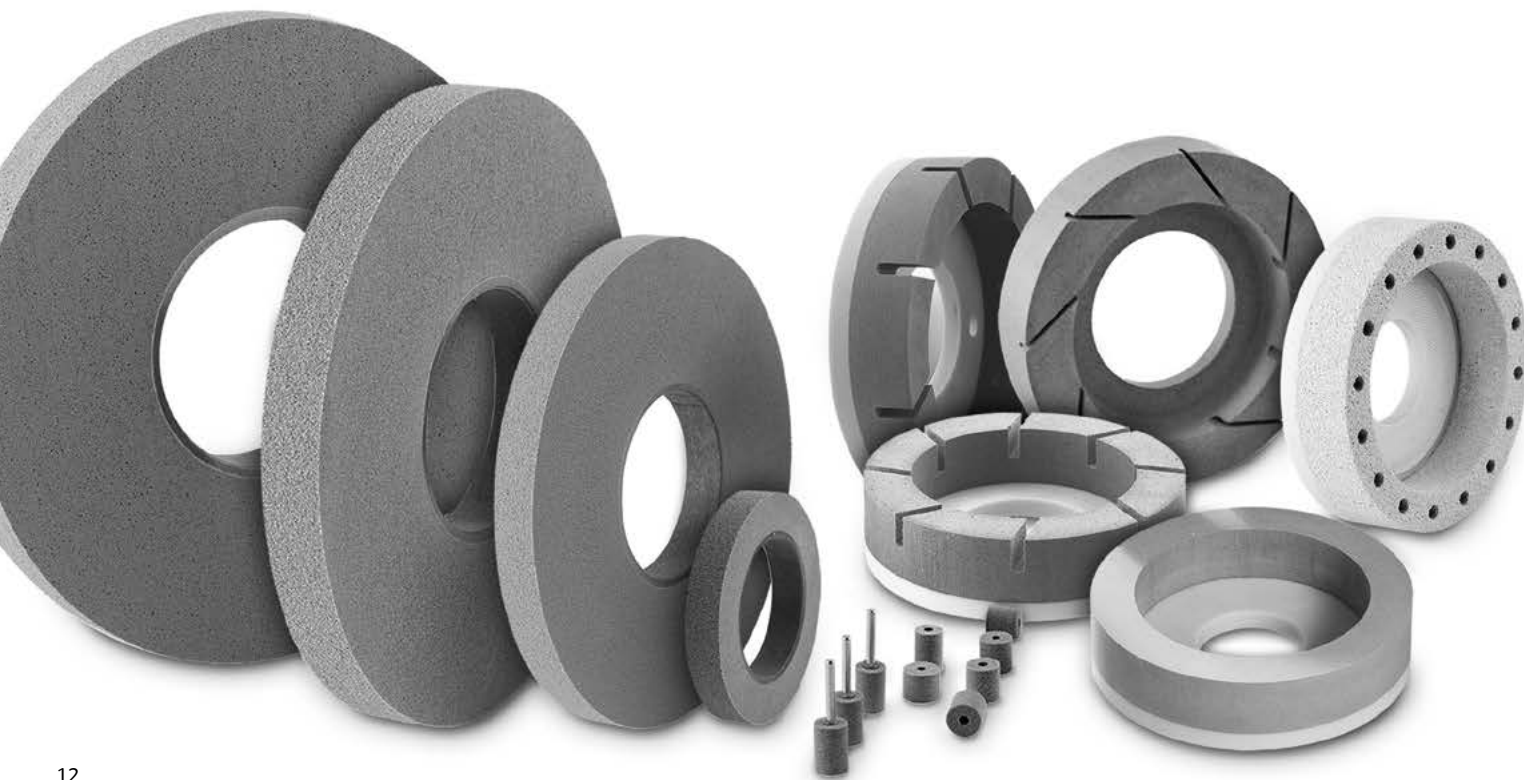



ARTIFEX Tools in Application

Regardless of whether flat edge, arris, miter, bevels or laminated glass: With our ARTIFEX product range, we equip single and double edger machines just like CNC milling machines, custom-fit and in all price groups. Depending on the application, the type of glass and the polishing result, we can provide the perfect tool for your machine.

We produce our elastically bound polishing tools for all standard machine types. You decide whether your priority lies on a high glass transparency or the perfect high shine. We have the right tools for you.

For initial equipping, we fit out many single and double edgers of renowned manufacturers like Benteler, Busetti, Neptun or Forvet. Of course, we also provide alternative tools besides the OEM tools made to customer specifications for almost all machines.

CUSTOM-FIT FOR SINGLE AND DOUBLE EDGERS

Each machine and glass has specific requirements. An ideally matched set of tools lets you obtain the optimum result. This set consists of polishing wheels with different grain sizes, abrasives and the corresponding arris wheels. ARTIFEX helps you to achieve perfect high gloss, long service lives or industrial gloss – just as you require.

DEPENDING ON CUSTOMER REQUIREMENTS, THE FOCUS OF OUR SERIES IS ON

- the highest life span
- perfect high gloss
- low tool costs

PERIPHERAL WHEELS FOR PERFECT PENCILS

Round edges, regardless of whether pencil, flat bull nose or half bull nose, have special requirements. Our

ARTIFEX tools for use on single and double edgers as well as CNC machines adapt to your requirements and to your budget. Here as well, we offer you the entire bandwidth from the perfectionist (BK – WR) and the classic (AO – UQ5) up to the more economic variant (EK – UJ).

THE PROS FOR LAMINATED GLASS

Laminated glass requires special processing. Due to the polymer foil between the flat glass panes, the cup wheels may become clogged and the glass edges can be covered with foil.

With the ARTIFEX special tools, these problems are a thing of the past. We offer all product series segmented with 3-mm or 5-mm slots for perfect laminated glass processing. Your advantage: no clogging of the cup wheels, no sticking of foil on the glass edges. This is how easy it is to process laminated glass.

EXPERTS FOR SMALL MACHINES

It is not always the large machines that achieve the ideal results for your requirements. Glass edge finishers with just a few polishing spindles can also be excellently equipped with our tools. It starts off with our polishing cup wheel quality AO – BQ6, followed by the rubber cerium oxide cup wheel CE – R that achieves optimum high gloss on the edge. If no diamond stations are available for the arris, this can be roughed up with the SC 280 HS cup wheels and polished out.

PERFECT HELPERS FOR DECOATING OF LOW-E-GLASS

Manual machines, vertical machines, cutting tables – there are various options to work on Low-E-Glass. In this context, each machine and each type of glass has its own requirements. ARTIFEX grinding wheels fulfil them all. This is because they are flexible with respect to grain size, type of abrasive grain and bonding strength. For variable application – custom-tailored to your demands.

The selection of the right composition depends on the layer to be stripped and the number of metal layers. Each manufacturer offers its own types of Low-E-Glass. To meet the requirements of varying suppliers, such as AGC, Guardian, Interpane or Saint-Gobain, ARTIFEX produces grinding disks that differ with respect to grain size, type of abrasive grain and bonding strength.

By the way: our ARTIFEX quality SC 150 HT scores with a special polyurethane bond and silicon carbide. They always pass the butterfly test with absolute certainty.

CUSTOM-FIT FOR MANUAL MACHINES

When using converted angle grinders or manual circular saws whose rpm value has been reduced, we typically recommend disks with a core reinforcement, such as the SG 100 HT.

Manufacturers: Bohle, Knopp, Pannkoke, Rottler & Rüdiger, and others.

PERFECT FOR VERTICAL MACHINES

We also stock different series for glass-working on vertical machines, depending on the coating strength or the integration of protective foil.

Manufacturers: Bystronic, Lenhardt, Lisec, and others.

IDEAL FOR CUTTING TABLES

For more complex processing methods on cutting tables with an integrated decoating unit, we offer different variants depending on requirements, for example for especially hard offline coatings or for glass with a protective foil such as Guardian TPF.

Manufacturers: Bottero, Bystronic, Hegla, Lisec, Macotec, and others.



Your Edges – Our Tools

Not all edges are alike. The type of glass, the thickness and the glass profile determine the tool. ARTIFEX offers the right polisher for any edge. The classic polishing cup wheels and disks by ARTIFEX already result in an outstanding industry gloss. Afterwards, the cerium oxide products of the CE series provide the perfect high gloss.

EDGE PROFILES	TYPE OF DELIVERY	BONDS FOR INDUSTRY GLOSS	BONDS FOR HIGH GLOSS
Flat	Cup wheel	Q, BQ, BJ, PR, PBR, R, N	CE
Miter (45°)			
Bevel			
LSG	Cup wheel, segmented	Q, BQ, BJ, PR, PBR, R, N	CE
Arris	Cup wheel	WS, MS, HS, SJ, R, N, Q	CE
Flat & arris	Peripheral wheel	UJ, UQ, N, R	CE – U
Bull nose			
Waterfall			
Triple waterfall			
OG edge			
Low-E and Solar Glass (decoating)	Sleeve, mounted point, peripheral wheel	T	

Double Edgers

Products for the Technology of Tomorrow

We proudly look back on a tradition spanning over 90 years in the fabrication of custom-fit grinding and polishing tools. As a globally operating manufacturer for the glass working industry, we develop and manufacture today the products for tomorrow's technology. Quality **Made in Germany** unites accuracy, productivity, reliability and efficiency.

We offer our polishing wheels for all machine types – from double edgers and CNC milling machines up to flexible smaller machines. Here you will find a selection of the manufacturers that use our tools on their machines successfully around the globe.

MANUFACTURER OVERVIEW

Bando	CMS	Gerhard	Neptun
Baudin	Covesa	Gieffe	Progetti
Bavelloni	Delta	GME	Schiatti
Benteler	Deltaprogetti	Golive	Sunrising
Besana	Demam	Hegla	Suntech
Bohle	Deway	Intermac	Systron
Bottero	Enkong	Knittel	Vitrododi
Bovone	FMF	Lattuada	Xinhaian
Busetti	Forel	Lisec	Zafferani
Bystronic	ForvetChiara	Macotec	Zanetti
C.A.U.	Fushan	Metral	ZXM

Of course, we also provide customised solutions for your specific polishing tasks. You will find a complete, interactive list with all machine equipment online at www.artifex-abrasives.de. On request, you can also obtain this list on a USB stick from our company or from our distribution partners.

BENTELER

tecGRINDER – 10 SPINDLES			
Position	Product	Dimensions	Term
Pos. 5	EK 400 WBS	170 x 40 x 68 / 125 mm	Z 201
Pos. 7	EK 400 WBS	170 x 40 x 68 / 125 mm	Z 201
Pos. 8	BK 40 PBR	170 x 40 x 68 / 125 mm	Z 201
Pos. 9	BK 60 PBR	170 x 40 x 68 / 125 mm	Z 201
Pos. 10	BK 180 WR1	170 x 40 x 68 / 125 mm	Z 201
alternative pos. 10	CE – 3	170 x 30 x 68 / 125 mm	Z 201

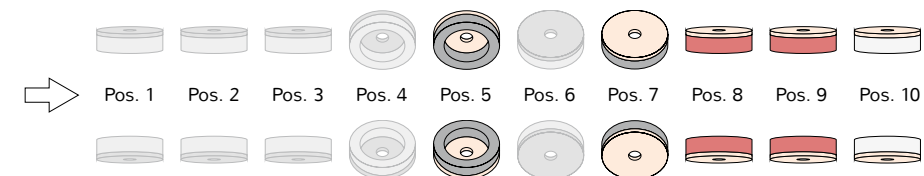

tecGRINDER – 11 SPINDLES			
Position	Product	Dimensions	Term
Pos. 5	EK 400 WBS	170 x 40 x 68 / 125 mm	Z 201
Pos. 7	EK 400 WBS	170 x 40 x 68 / 125 mm	Z 201
Pos. 8	BK 40 PBR	170 x 40 x 68 / 125 mm	Z 201
Pos. 9	BK 60 PBR	170 x 40 x 68 / 125 mm	Z 201
Pos. 10	BK 180 WR1	170 x 40 x 68 / 125 mm	Z 201
Pos. 11	CE – 3	170 x 30 x 68 / 125 mm	Z 201

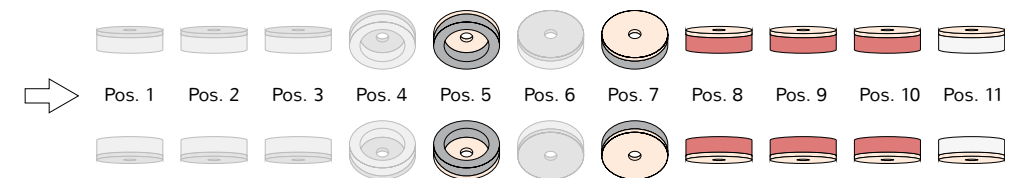

BUSETTI

F 10			
Position	Product	Dimensions	Term
Pos. 5	EK 400 MS	150 x 60 x 70 / 110 mm	So. 7696
Pos. 6	AO 40 BQ5	150 x 40 x 70 / 105 mm	Z 012
Pos. 7	AO 60 BQ5	150 x 40 x 70 / 105 mm	Z 012
Pos. 8	CE – 3	150 x 47 x 70 / 110 mm	So. 7560
Pos. 10	EK 400 MS	150 x 60 x 70 / 110 mm	So. 7696

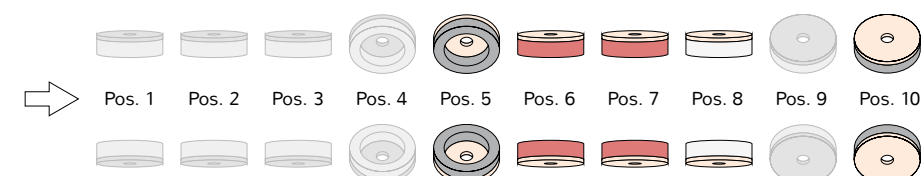

BUSETTI

F 12			
Position	Product	Dimensions	Term
Pos. 6	EK 400 MS	150 x 60 x 70 / 110 mm	So. 7696
Pos. 7	AO 40 BQ5	150 x 40 x 70 / 105 mm	Z 012
Pos. 8	AO 40 BQ5	150 x 40 x 70 / 105 mm	Z 012
Pos. 9	AO 60 BQ5	150 x 40 x 70 / 105 mm	Z 012
Pos. 10	CE - 3	150 x 47 x 70 / 110 mm	So. 7560
Pos. 12	EK 400 MS	150 x 60 x 70 / 110 mm	So. 7696

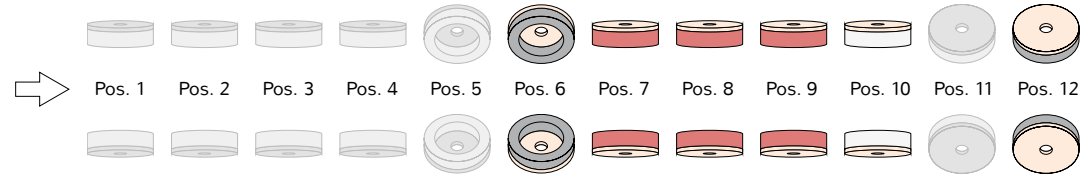

BESANA

SQ 10 T			
Position	Product	Dimensions	Term
Pos. 6	AO 120 Q4	125 x 50 x 25 / 80 mm	So. 6357
Pos. 7	AO 120 Q4	125 x 50 x 25 / 80 mm	So. 6357
Pos. 8	AO 40 Q6	150 x 40 x 25 / 110 mm	So. 3672
Pos. 9	AO 60 Q6	150 x 40 x 25 / 110 mm	So. 3673
Pos. 10	CE - 3	150 x 40 x 25 / 110 mm	So. 7999

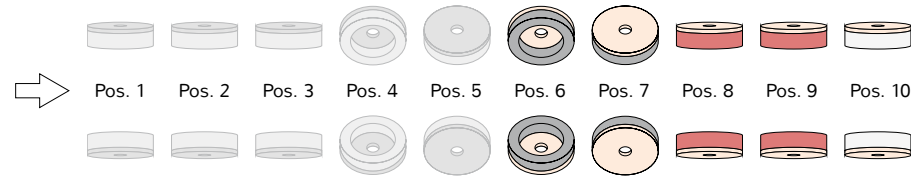

BOTTERO

TITAN 220			
Position	Product	Dimensions	Term
Pos. 5	EK 120 SJ	150 x 40 x 50 / 105 mm	Full material cup wheel Z 102
alternative pos. 5	EK 120 SJ	130 x 35 x 50 / 90 mm	Full material cup wheel Z 102
Pos. 7	EK 120 SJ	150 x 40 x 50 / 105 mm	Full material cup wheel Z 102
alternative pos. 7	EK 120 SJ	130 x 35 x 50 / 90 mm	Full material cup wheel Z 102
Pos. 8	AO 40 BQ6	150 x 40 x 50 / 105 mm	Z 102
Pos. 9	AO 60 BQ6	150 x 40 x 50 / 105 mm	Z 102
Pos. 10	CE - 3	150 x 40 x 50 / 110 mm	Z 103

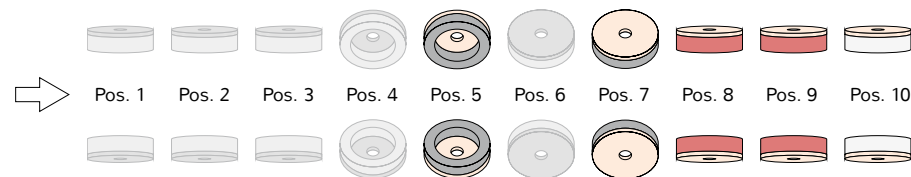

BAVELLONI

VX 10			
Position	Product	Dimensions	Term
Pos. 5	EK 400 WS	150 x 40 x 70 / 110 mm	So. 7699
Pos. 7	EK 400 WS	150 x 40 x 70 / 110 mm	So. 7699
Pos. 8	AO 40 BQ6	150 x 40 x 70 / 105 mm	So. 8238
Pos. 9	AO 60 BQ6	150 x 40 x 70 / 105 mm	So. 8241
Pos. 10	CE - 3	150 x 40 x 70 / 110 mm	Z 005

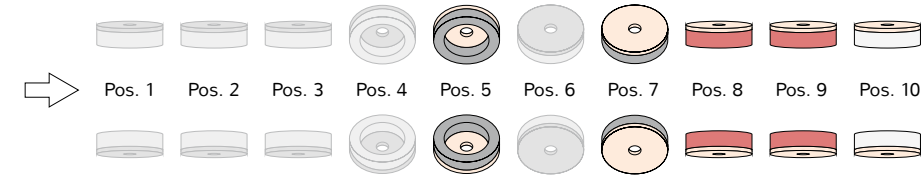

GOLIVE

SDE 2616			
Position	Product	Dimensions	Term
Pos. 6	BK 60 WN1	130 x 35 x 60 / 90 mm	So. 7711
Pos. 7	BK 60 WN1	130 x 35 x 60 / 90 mm	So. 7711
Pos. 8	BK 60 WN1	130 x 35 x 60 / 90 mm	So. 7711
Pos. 9	BK 60 WN1	130 x 35 x 60 / 90 mm	So. 7711
Pos. 10	BK 46 WN1	150 x 40 x 70 / 100 mm	So. 7715
Pos. 11	BK 60 WN1	150 x 40 x 70 / 100 mm	So. 7714
Pos. 12	BK 60 WN1	150 x 40 x 70 / 100 mm	So. 7714
Pos. 13	CE - 3	150 x 40 x 70 / 90 mm	So. 8396

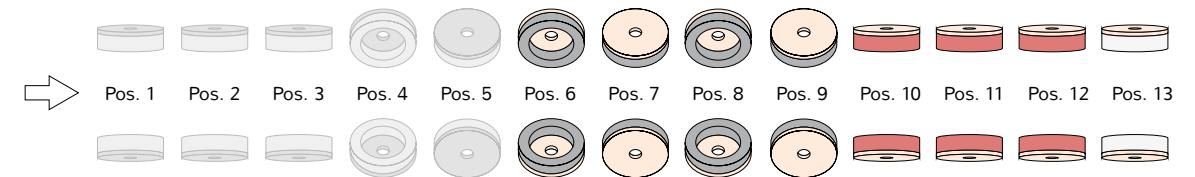

GME

MB 10 PN			
Position	Product	Dimensions	Term
Pos. 5	EK 400 WS	150 x 40 x 70 / 110 mm	So. 7699
Pos. 7	EK 400 WS	150 x 40 x 70 / 110 mm	So. 7699
Pos. 8	AO 40 BQ6	150 x 40 x 70 / 105 mm	So. 8238
Pos. 9	AO 60 BQ6	150 x 40 x 70 / 105 mm	So. 8241
Pos. 10	CE - 3	150 x 40 x 70 / 110 mm	Z 005

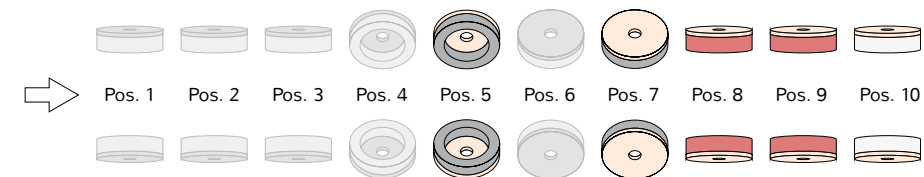

SCHIATTI

BFT 8 MINI			
Position	Product	Dimensions	Term
Pos. 3	BK 60 WN1	200 x 15 / 20 x 90 mm	without
Pos. 4	BK 120 WN1	200 x 15 / 20 x 90 mm	without



Single Edgers

BOTTERO

VICTRALUX 111 F – Single-sided edge			
Position	Product	Dimensions	Term
Pos. 5	EK 120 SJ	150 x 40 x 50 / 105 mm Full material cup wheel	Z 102
Pos. 7	EK 120 SJ	150 x 40 x 50 / 105 mm Full material cup wheel	Z 102
Pos. 8	AO 40 BQ6	150 x 40 x 50 / 105 mm	Z 102
Pos. 9	AO 60 BQ6	150 x 40 x 50 / 105 mm	Z 102
Pos. 10	AO 80 BQ6	150 x 40 x 50 / 105 mm	Z 102
Pos. 11	CE – 3	150 x 40 x 50 / 110 mm	Z 103

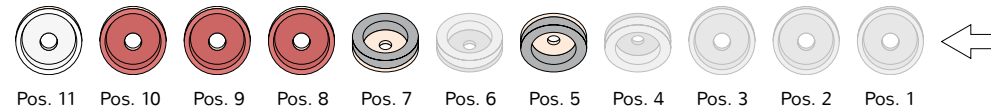

VARIANT 814 – One-sided miter			
Position	Product	Dimensions	Term
Pos. 4	AO 40 BQ6	150 x 40 x 50 / 105 mm	Z 102
Pos. 5	AO 60 BQ6	150 x 40 x 50 / 105 mm	Z 102
Pos. 6	CE – 3	150 x 40 x 50 / 110 mm	Z 103
Pos. 9	EK 120 SJ	150 x 40 x 50 / 105 mm Full material cup wheel	Z 102
Pos. 11	EK 120 SJ	150 x 40 x 50 / 105 mm Full material cup wheel	Z 102
Pos. 12	AO 60 BQ6	150 x 40 x 50 / 105 mm	Z 102
Pos. 13	CE – R	150 x 40 x 50 / 110 mm	Z 103
Pos. 14	CE – R	150 x 40 x 50 / 110 mm	Z 103

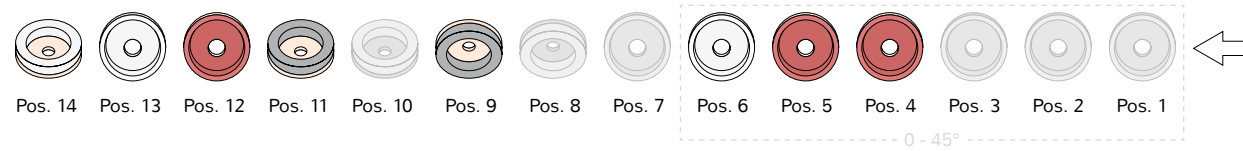

BAVELLONI

PR 88 – Single-sided edge			
Position	Product	Dimensions	Term
Pos. 4	EK 400 WS	100 x 35 x 11 / 60 mm	So. 8294
Pos. 6	EK 400 WS	100 x 35 x 11 / 60 mm	So. 8294
Pos. 7	AO 60 BQ6	150 x 40 x 70 / 105 mm	So. 8241
Pos. 8	CE – R	150 x 40 x 70 / 110 mm	Z 005



GEMY V 14 – One-sided miter			
Position	Product	Dimensions	Term
Pos. 6	AO 40 BQ6	150 x 40 x 70 / 105 mm	So. 8238
Pos. 7	AO 60 BQ6	150 x 40 x 70 / 105 mm	So. 8241
Pos. 8	CE – 3	150 x 40 x 70 / 110 mm	Z 005
Pos. 11	EK 400 WS	150 x 40 x 70 / 110 mm	So. 7699
Pos. 12	EK 400 WS	150 x 40 x 70 / 110 mm	So. 7699
Pos. 13	AO 60 BQ6	150 x 40 x 70 / 105 mm	So. 8241
Pos. 14	CE – R	150 x 40 x 50 / 110 mm	Z 005

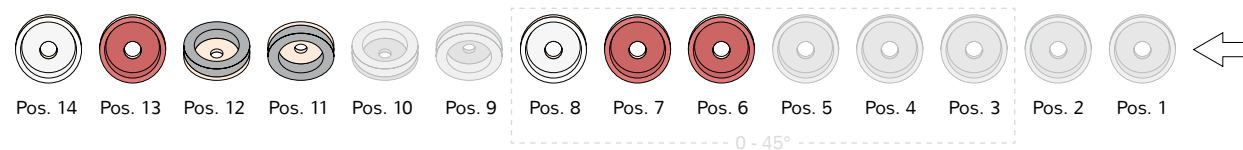

BAUDIN

BAUDIN 681			
Position	Product	Dimensions	Term
Pos. 3	AO 60 Q6	150 x 40 x 70 / 110 mm	So. 7873
Pos. 4	CE – 3	150 x 40 x 70 / 110 mm	So. 7994
Pos. 5	SC 280 HS	150 x 40 x 70 / 110 mm	So. 3630
Pos. 6	SC 280 HS	150 x 40 x 70 / 110 mm	So. 3630



BAUDIN 981			
Position	Product	Dimensions	Term
Pos. 3	AO 40 Q6	150 x 40 x 70 / 110 mm	So. 7870
Pos. 4	AO 60 Q6	150 x 40 x 70 / 110 mm	So. 7873
Pos. 5	CE – 3	150 x 40 x 70 / 110 mm	So. 7994
Pos. 7	AO 120 Q4	150 x 40 x 70 / 110 mm	So. 4052
Pos. 9	AO 120 Q4	150 x 40 x 70 / 110 mm	So. 4052

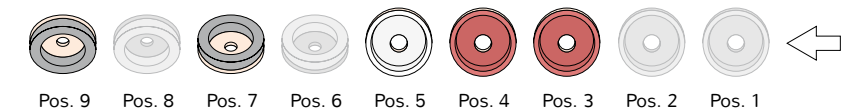

LATTUADA

AL 10 M – Single-sided edge			
Position	Product	Dimensions	Term
Pos. 5	AO 120 Q4	100 x 35 x 30 / 50 mm	So. 7978
Pos. 7	AO 120 Q4	100 x 35 x 30 / 50 mm	So. 7978
Pos. 8	AO 40 BQ6	150 x 30 x 50 / 83 / 105 mm	Z 007
Pos. 9	AO 60 BQ6	150 x 30 x 50 / 83 / 105 mm	Z 007
Pos. 10	CE – 3	150 x 30 x 50 / 83 / 110 mm	So. 5507



TLR 11 AV – One-sided miter			
Position	Product	Dimensions	Term
Pos. 5	AO 40 BQ6	150 x 30 x 50 / 83 / 105 mm	Z 007
Pos. 6	AO 60 BQ6	150 x 30 x 50 / 83 / 105 mm	Z 007
Pos. 7	CE – 3	150 x 30 x 50 / 83 / 110 mm	So. 5507
Pos. 9	AO 120 Q4	130 x 35 x 50 / 80 mm	So. 4057
Pos. 11	AO 120 Q4	130 x 35 x 50 / 80 mm	So. 4057

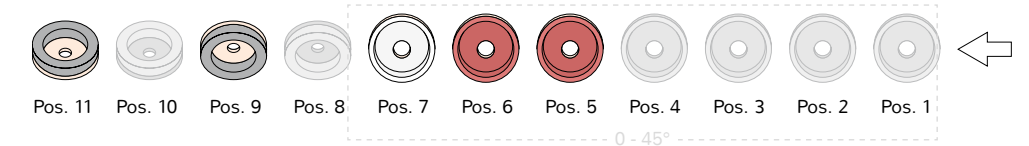

SCHIATTI

FPS 10 S			
Position	Product	Dimensions	Term
Pos. 4	EK 120 SJ	125 x 35 x 22 / 90 mm Full material cup wheel	without
Pos. 5	EK 120 SJ	125 x 35 x 22 / 90 mm Full material cup wheel	without
Pos. 6	AO 80 BQ6	150 x 40 x 68 / 105 mm	Z 320

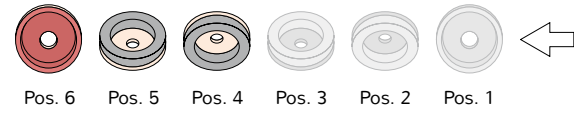

FPS 15			
Position	Product	Dimensions	Term
Pos. 5	EK 120 SJ	125 x 35 x 22 / 90 mm Full material cup wheel	without
Pos. 6	EK 120 SJ	125 x 35 x 22 / 90 mm Full material cup wheel	without
Pos. 7	AO 60 BQ6	150 x 40 x 22 / 105 mm	Z 320
Pos. 8	CE - 3	150 x 40 x 22 / 105 mm	Z 321



ZAFFERANI

JUNIOR 2 M 12 AND SENIOR 2 M 22			
Position	Product	Dimensions	Term
Pos. 2	BK 60 WR1	200 x 20 x 90 mm	So. 0521



FLAT 8 BS			
Position	Product	Dimensions	Term
Pos. 3	AO 40 BQ6	150 x 40 x 50 / 105 mm	So. 8244
Pos. 4	CE - 3	150 x 40 x 50 / 110 mm	So. 8404
Pos. 5	SC 280 HS	100 x 30 x 50 / 60 mm Full material cup wheel	without
Pos. 6	SC 280 HS	100 x 30 x 50 / 60 mm Full material cup wheel	without
Pos. 7	CE - 2	100 x 30 x 50 / 60 mm	So. 8424
Pos. 8	CE - 2	100 x 30 x 50 / 60 mm	So. 8424

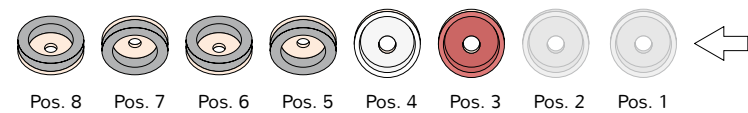

NEPTUN

ROCK 8 - Single-sided edge			
Position	Product	Dimensions	Term
Pos. 4	EK 400 WS	100 x 35 x 11 / 60 mm	So. 8294
Pos. 6	EK 400 WS	100 x 35 x 11 / 60 mm	So. 8294
Pos. 7	AO 40 BQ6	150 x 40 x 70 / 105 mm	So. 8238
Pos. 8	CE - 3	150 x 40 x 70 / 110 mm	So. 7994



ROCK 10/45 - One-sided miter			
Position	Product	Dimensions	Term
Pos. 4	AO 40 BQ6	150 x 40 x 70 / 105 mm	So. 8238
Pos. 5	AO 60 BQ6	150 x 40 x 70 / 105 mm	So. 8241
Pos. 6	CE - 3	150 x 40 x 70 / 110 mm	So. 7994
Pos. 9	EK 400 WS	100 x 35 x 11 / 60 mm	So. 8294
Pos. 10	EK 400 WS	100 x 35 x 11 / 60 mm	So. 8294

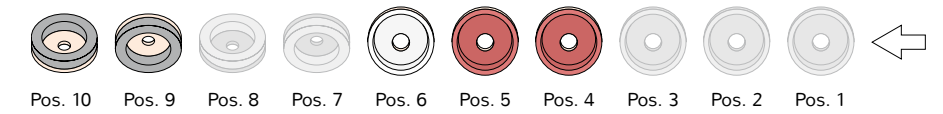

ENKONG

ENKONG ZM8			
Position	Product	Dimensions	Term
Pos. 3	AO 60 BQ6	150 x 40 x 12 / 105 mm	Z 328
Pos. 4	CE - 3	150 x 40 x 70 / 90 mm	So. 8396
Pos. 6	EK 120 SJ	130 x 35 x 60 / 90 mm Full material cup wheel	without
Pos. 8	EK 120 SJ	130 x 35 x 60 / 90 mm Full material cup wheel	without

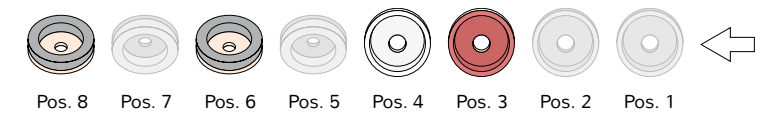

BOVONE

ELB 10 - Single-sided edge			
Position	Product	Dimensions	Term
Pos. 5	EK 400 WS	150 x 50 x 22 / 110 mm	So. 8385
Pos. 7	EK 400 WS	150 x 50 x 22 / 110 mm	So. 8385
Pos. 10	CE - 3	170 x 35 x 60.15 / 130 mm	E 637



ELB 10/45 - One-sided miter			
Position	Product	Dimensions	Term
Pos. 6	CE - 3	170 x 35 x 60.15 / 130 mm	E 637
Pos. 8	EK 400 WS	150 x 50 x 22 / 110 mm	So. 8385
Pos. 10	EK 400 WS	150 x 50 x 22 / 110 mm	So. 8385

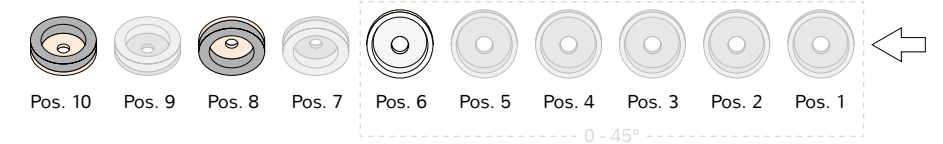

SELIM

SE 9 M			
Position	Product	Dimensions	Term
Pos. 5	BK 60 WN1	130 x 35 x 60 / 90 mm	So. 7711
Pos. 7	BK 60 WN1	130 x 35 x 60 / 90 mm	So. 7711
Pos. 8	BK 60 WN1	150 x 40 x 70 / 100 mm	So. 7714
Pos. 9	CE - 3	150 x 40 x 70 / 90 mm	So. 8396



CNC Milling Machines

INTERMAC

MASTER EDGE			
Application	Product	Dimensions	Term
Edge polishing	AO 180 UQ5	100 x X x 22 mm	Width varies
High-gloss edge polishing	CE - U	100 x X x 22 mm	Width varies
Abrasive sleeve for inside radiuses	AO 180 UQ5	25 x X x 6 mm	Width varies
Cup wheel for high gloss (for 5 axes only)	CE - 3	150 x 40 x 22 / 110 mm	So. 8337

VERTMAX			
Application	Product	Dimensions	Term
Edge polishing	AO 180 UQ5	150 x 20 x 22 mm	without

CMS

BOB, B 7, FUTURA			
Application	Product	Dimensions	Term
Edge polishing	AO 180 UQ5	100 x X x 22 mm	Width varies
High-gloss edge polishing	CE - U	100 x X x 22 mm	Width varies

FORVET

CHIARA - WHEELS WITH ALUMINIUM SUPPORT			
Position	Product	Dimensions	Term
Pos. 4	EK 120 SJ	75 x 37 x 9 / 32 mm	Z 501
Pos. 6	EK 120 SJ	75 x 37 x 9 / 32 mm	Z 501
Pos. 7	AO 40 BQ6	75 x 37 x 9 / 32 mm	Z 501
Pos. 8	CE - 3	75 x 37 x 9 / 32 mm	Z 501

CHIARA - ALTERNATIVE RINGS FOR AFFIXING			
Position	Product	Dimensions	Term
Pos. 4	EK 120 SJ	75 x 21 x 32 mm	without
Pos. 6	EK 120 SJ	75 x 21 x 32 mm	without
Pos. 7	AO 40 BJ	75 x 21 x 32 mm	without
Pos. 8	CE - 3	75 x 21 x 32 mm	without

FOREL

FOREL EM			
Application	Product	Dimensions	Term
Edge polishing	AO 120 UQ5	200 x X x 35 mm	Width varies

LISEC

WSL			
Application	Product	Dimensions	Term
Edge polishing	AO 180 UQ5	100 x X x 22 mm	Width varies
Abrasive sleeve for inside radiuses	AO 180 UQ5	25 x X x 6 mm	Width varies

SYSTRON

6033 PER HD			
Application	Product	Dimensions	Term
Edge polishing	AO 180 UQ5	100 x X x 22 mm	Width varies
Abrasive sleeve for inside radiuses	AO 180 UQ5	25 x X x 6 mm	Width varies

Model bevel

BAVELLONI

SB 10			
Application	Product	Dimensions	Term
Edge polishing	AO 180 UQ5	100 x X x 22 mm	Width varies
Bevel (pos. 3)	AO 40 BJ	150 x 25 x 100 / 125 mm	Z 326

GIEFFE

BILUX			
Application	Product	Dimensions	Term
Edge polishing	AO 180 UQ5	100 x X x 22 mm	Width varies
Bevel (pos. 3)	AO 40 Q7	150 x 36 x 10 / 125 mm	So. 6365

Decoating of LOW-E | Solar Glass

The selection of the right tool depends on the layer to be stripped and the number of metal layers. Amongst others, these consist of silver, copper and stannic oxide. Each manufacturer offers its own types of glass. For example, LOW-E (soft) or Sun Stop|Solar (hard). These are supplied by AGC, Glaverbel, Guardian, Interpane, Saint-Gobain, Sanco, Semco and Pilkington, among others.

MANUAL MACHINES E.G. BOHLE | KNOPP | PANNKOKE | ROTTLE & RÜDIGER AND OTHERS

APPLICATION	PRODUCT	DIMENSIONS (MM)			MAX. RPM	M/S
		Ø D	T	Ø H		
Standard	SG 100 HT	125	10	25.40 76.20	4,580	30
		150	10	25.40 76.20	3,810	30
For hard coatings and glass with protective foil	SK 120 HT	125	10	25.40 76.20	4,580	30
		150	10	25.40 76.20	3,810	30
Long service life	SC 80 MT	125	10	25.40 76.20	3,810	25
		150	10	25.40 76.20	3,180	25
Butterfly test for quality assurance	SC 150 HT	125	10	25.40 76.20	4,580	30
		150	10	25.40 76.20	3,810	30

Type of delivery: Peripheral wheel with core | Other dimensions on request

VERTICAL MACHINES E.G. BYSTRONIC | LENHARDT | LISEC, AND OTHERS

APPLICATION	PRODUCT	DIMENSIONS (MM)			MAX. RPM	M/S
		Ø D	T	Ø H		
Standard	NK 220 HT	175	10	76.20	3,270	30
		200	10	76.20	2,860	30
For hard coatings and glass with protective foil	SK 120 HT	175	10	76.20	3,270	30
		200	10	76.20	2,860	30
Long service life	SC 80 MT	175	10	76.20	2,720	25
		200	10	76.20	2,380	25
Butterfly test for quality assurance	SC 150 HT	175	10	76.20	3,270	30
		200	10	76.20	2,860	30

Type of delivery: Peripheral wheel with core | Other dimensions on request

CUTTING TABLES E.G. BAVELLONI | BOTTERO | BYSTRONIC | HEGLA | INTERMAC | LISEC | MACOTEC, AND OTHERS

APPLICATION	PRODUCT	DIMENSIONS (MM)			MAX. RPM	M/S
		Ø D	T	Ø H		
Standard	NK 220 HT	175	8-60	76.20	3,270	30
		200	8-60	76.20	2,860	30
		19.50 *	20	6.00	29,300 min ⁻¹	30
For hard coatings and glass with protective foil	SK 120 HT	175	8-60	76.20	3,270	30
		200	8-60	76.20	2,860	30
		19.50 *	20	6.20	29,300 min ⁻¹	30
Long service life	SC 80 MT	175	8-60	76.20	2,720	25
		200	8-60	76.20	2,380	25
Butterfly test for quality assurance	SC 150 HT	175	8-60	76.20	3,270	30
		200	8-60	76.20	2,860	30

Type of delivery: Peripheral wheel with core | *Sleeves | Other dimensions on request

MODEL GLASS E.G.: BAVELLONI REV 372 SR | TUROMAS | GFPM AND OTHERS

APPLICATION	PRODUCT	DIMENSIONS (MM)			MAX. RPM	M/S
		Ø D	T	Ø H		
Standard	SG 100 HT	19.50 *	20	6.00	29,300 min ⁻¹	30
		19.80 *	30	7.50	28,900 min ⁻¹	30
		20.00	30	6.00 shaft	33,300 min ⁻¹	30
Standard	NK 220 HT	19.50 *	20	6.00	29,300 min ⁻¹	30
		19.80 *	30	7.50	28,900 min ⁻¹	30
		20.00	30	6.00 shaft	22,700 min ⁻¹	30
For hard coatings and glass with protective foil	SK 120 HT	19.50 *	20	6.00	29,300 min ⁻¹	30
		19.80 *	30	7.50	28,900 min ⁻¹	30
		20.00	30	6.00 shaft	28,700 min ⁻¹	30

Type of delivery: Mounted points | *Sleeves | Other dimensions on request



The ARTIFEX promise

We stand for tools that guarantee the highest quality standards. All ARTIFEX products are "**Made in Germany**" and their above-average service life speaks for itself.

Our Service: You have individual requirements – we offer customised solutions regardless of the material, shape or dimensions. We will gladly advise you on your premises.



ARTIFEX Dr. Lohmann GmbH & Co. KG
Feldstrasse 8 | DE-24568 Kaltenkirchen
Telephone: +49 (0) 4191 935 – 0
info@artifex-abrasives.de | www.artifex-abrasives.de

