



FPH

PRESSURE FILTERS

DESCRIPTION

3-way inline filter

MATERIALS

Head: Aluminum alloy

Bowl: Steel

Bypass valve: Polyamide

Seals: NBR Nitrile (FKM Fluoroelastomer on request)

Indicator housing: Brass

PRESSURE

Max working: 2 MPa (20 bar)

Collapse, differential for the filter element:

300 kPa (3 bar)

BYPASS VALVE

Setting: 170 kPa (1,7 bar) \pm 10%

FLOW RATE

Qmax 400 l/min

WORKING TEMPERATURE

From -25° to +110° C

COMPATIBILITY (ISO 2943)

Full with fluids: HH-HL-HM-HV-HTG

(according to ISO 6743/4)

For fluids different than the above mentioned,
please contact our Sales Department.

HYDRAULIC DIAGRAM

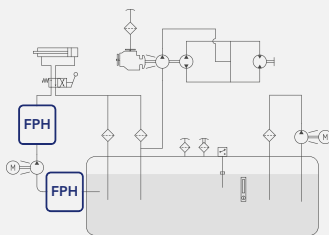

Is this datasheet the latest release? Please check on our website



FPH

PRESSURE FILTERS



ORDERING AND OPTION CHART

F	P	H	COMPLETE FILTER FAMILY					FILTER ELEMENT FAMILY	E	R	A
			SIZE & LENGTH	31	40	50	52	SIZE & LENGTH			
			PORT TYPE								
			B = BSP thread	B	B	B	B				
			N = NPT thread	N	N	N	N				
			PORT SIZE								
			03 = 3/8"	03	-	-	-				
			04 = 1/2"	04	-	-	-				
			06 = 3/4"	-	06	-	-				
			08 = 1"	-	08	-	-				
			10 = 1" 1/4	-	-	10					
			12 = 1" 1/2	-	-	-	12				
		B	BYPASS VALVE								
			B = 170 kPa (1,7 bar)	B	B	B	B				
			SEALS					SEALS			
			N = NBR Nitrile	N	N	N	N				
			F = FKM Fluoroelastomer	F	F	F	F				
			FormulaUFI MEDIA					FormulaUFI MEDIA			
			FA = FormulaUFI.MICRON 5 $\mu\text{m}_{(c)}$ $\beta > 1.000$	FA	FA	FA	FA				
			FB = FormulaUFI.MICRON 7 $\mu\text{m}_{(c)}$ $\beta > 1.000$	FB	FB	FB	FB				
			FC = FormulaUFI.MICRON 12 $\mu\text{m}_{(c)}$ $\beta > 1.000$	FC	FC	FC	FC				
			FS = FormulaUFI.MICRON 16 $\mu\text{m}_{(c)}$ $\beta > 1.000$	FS	FS	FS	FS				
			FD = FormulaUFI.MICRON 21 $\mu\text{m}_{(c)}$ $\beta > 1.000$	FD	FD	FD	FD				
			FE = FormulaUFI.MICRON 30 $\mu\text{m}_{(c)}$ $\beta > 1.000$	FE	FE	FE	FE				
			ME = FormulaUFI.WEB 60 μm	ME	ME	ME	ME				
			MF = FormulaUFI.WEB 90 μm	MF	MF	MF	MF				
			CLOGGING INDICATOR**								
			03 = port, plugged	03	03	03	03				
			5B = visual differential 130 kPa (1,3 bar)	5B	5B	5B	5B				
			6B = electrical differential 130 kPa (1,3 bar)	6B	6B	6B	6B				
			7B = indicator 6E with LED	7B	7B	7B	7B				
			T0 = elect. diff. 130 kPa (1,3 bar) with thermostat 30°C	T0	T0	T0	T0				
			0R = 1/8" predisposition	0R	0R	0R	0R				
			31 = pressure gauge, rear connection	31	31	31	31				
			P1 = SPDT, pressure switch	P1	P1	P1	P1				
			10 = vacuum gauge	10	10	10	10				
			91 = vacuum switch	91	91	91	91				
X	X		ACCESSORI / ACCESSORIES								
			XX = no accessory available	XX	XX	XX	XX				

** When the filter is ordered with FKM seals, the first digit of the indicator code is a letter (please see Clogging Indicator Chapter for further details)

SPARE PARTS

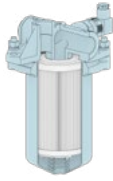
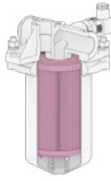
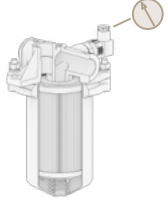
FILTER HOUSING				FILTER ELEMENT				CLOGGING INDICATOR					
													
B	P	H		B			X	E	R	A			

SPARE SEAL KIT

NBR		FKM		NBR		FKM		NBR		FKM	
FPH31	521.0006.2	521.0075.2	FPH40	521.0007.2	521.0076.2	FPH50-52	521.0008.2	521.0077.2			

INSTALLATION DRAWING

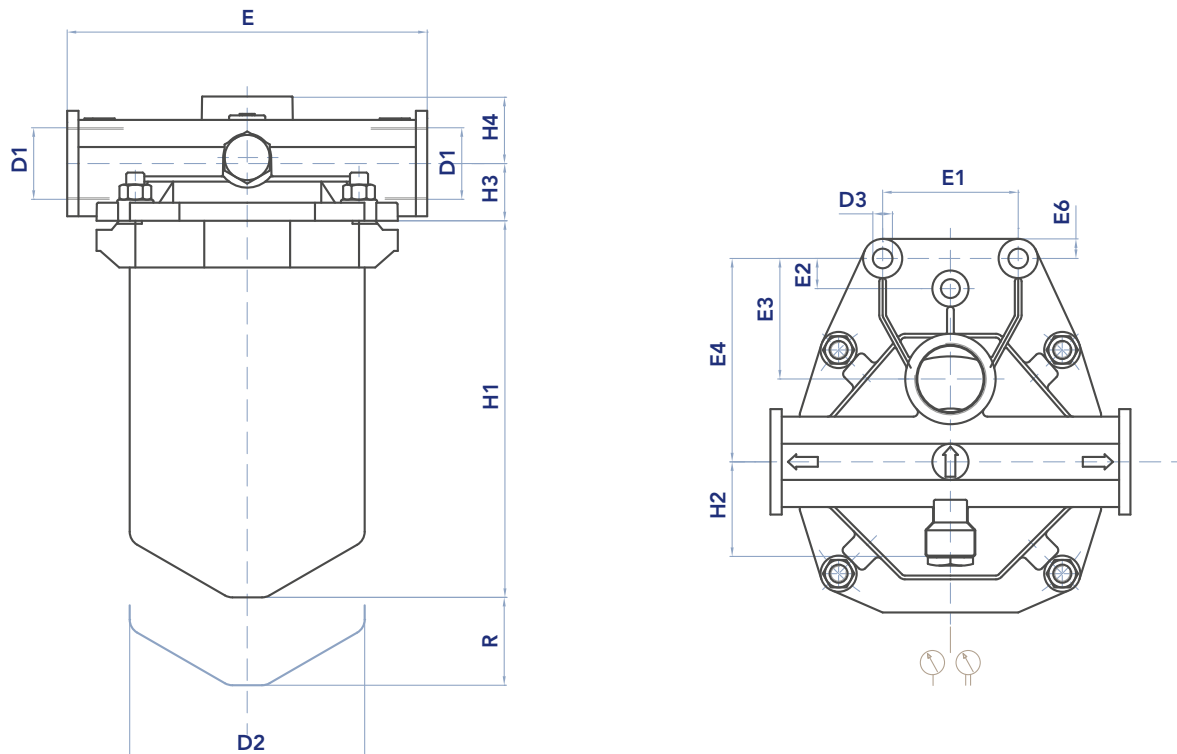

FILTER HOUSING

	D1	D2	D3	E	E1	E2	E3	E4	E6	H1	H2	H3	H4	R	kg
FPH31	3/8" - 1/2"	81	11	114	50	-	42	70	10	114	44	19	27	20	1,3
FPH40	3/4" - 1"	114	13	150	50	-	50	85	13	212	58	30	35	20	3,2
FPH50	1"1/4	156	13	240	90	20	80	135	13	200	62	38	45	25	6,1
FPH52	1"1/2	156	13	240	90	20	80	135	13	265	62	38	45	25	6,8

FPH

PRESSURE FILTERS



FILTER ELEMENT

	AREA (cm ²)			Kg	Media F+	Media M+
	A	B	C			
ERA31	70	28	85	0,20	620	990
ERA40	99	40	170	0,60	3.630	3.390
ERA50	130	63	140	1,00	4.450	4.360
ERA52	130	63	200	1,35	6.190	6.520



MAINTENANCE

- 1) Stop the system and verify there is no pressure in the filter.
- 2) Collect the oil inside the filter with a suitable container.
- 3) Unscrew the nuts (1) to disassemble the flange (2) from the bowl (3) positioned below the head (4). N.B. The bowl is in contact only with the flange.
- 4) Empty and clean the bowl (3). Make sure the gasket (5) and the spring (6) remain on the bottom of the bowl. These parts have to be reused.
- 5) Remove the dirty filter element (7).
N.B. The exhausted filter elements and the oil dirty filter parts are classified "Dangerous waste material" and must be disposed of according to the local laws, by authorized Companies.
- 6) Check the filter element part number on the filter label or in the ordering and option chart.
Use only original spare parts.
- 7) Lubricate the element o-ring gasket (8) with oil.
- 8) Insert the clean element into its seat with care.
- 9) Fit the bowl into the flange and place the flat gasket. The spring must be centred on the bottom of the bowl.
- 10) Place the flange against the head, centering the 4 threaded pins.
- 11) Screw manually a nut and its washer (1) onto the stud without locking. Repeat the same operation with the opposite nut, and then with the remaining two.
- 12) Tighten all nuts gradually with the cross system until the bowl is completely locked, to ensure the correct adhesion between the container and the head.

Accessories:

Clogging indicator (9).

If damaged, unscrew and replace it (check the part number in the ordering and option chart). Follow the instruction (a) or (b) according to the type of indicator in use.

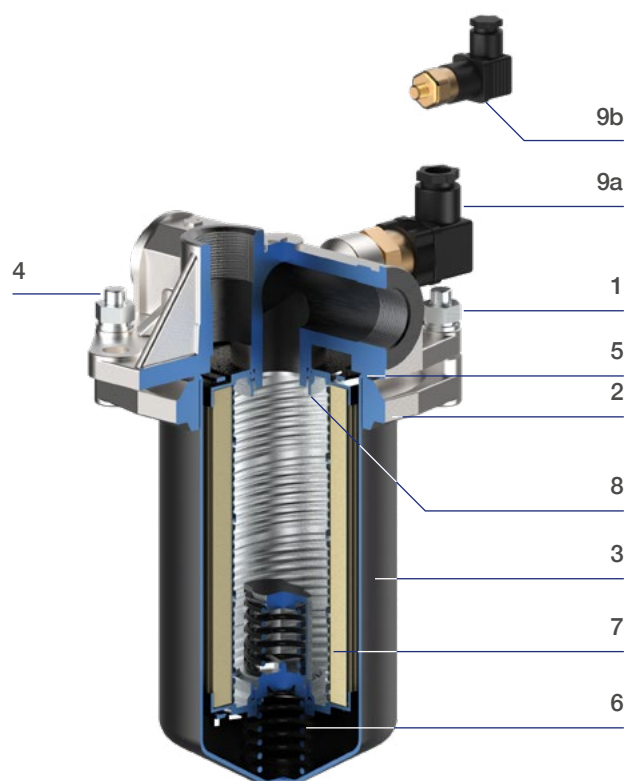

- a) Differential clogging indicator with metric thread connection (9a). Lubricate the o-ring gaskets with oil and screw until stop, with a tightening torque of 40 Nm +5/0.
- b) Clogging indicator with 1/8" thread connection (9b). Apply a thread-sealing and screw until tight. An over-tightening can damage the thread.



PRESSURE DROP CURVES (Δp)

The “Assembly Pressure Drop (Δp)” is obtained by adding the pressure drop values of the Filter Housing and of the Clean Filter Element corresponding to the considered Flow Rate and it must

be lower than 50 kPa (0,5 bar). In any case this value should never exceed 1/3 of the bypass setting.

FILTER HOUSING PRESSURE DROP
(mainly depending on the port size)

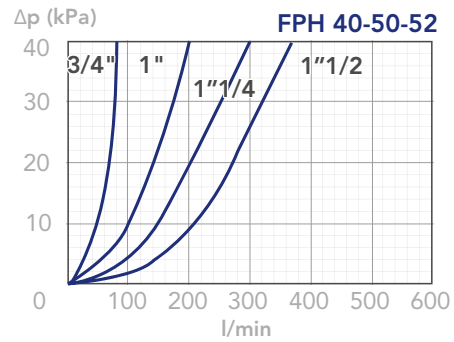
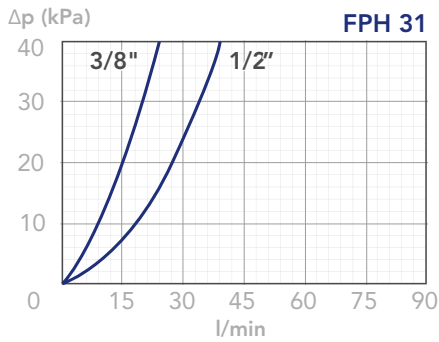

CLEAN FILTER ELEMENT PRESSURE DROP WITH F+ AND M+ MEDIA
(depending both on the internal diameter of the element and on the filter media)

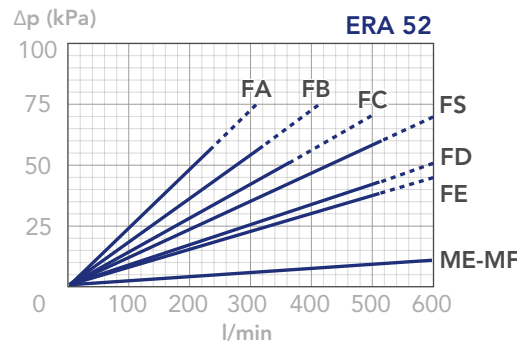
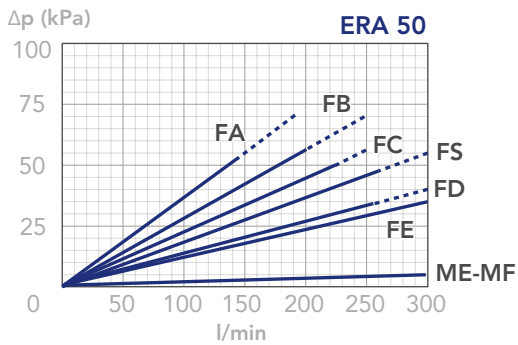
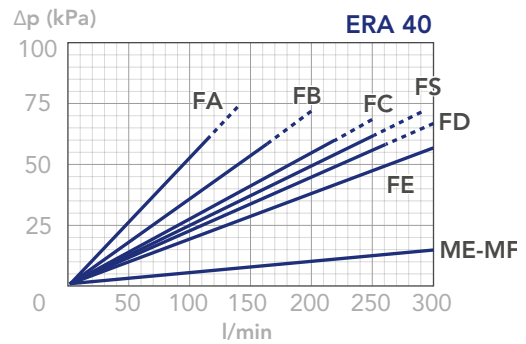
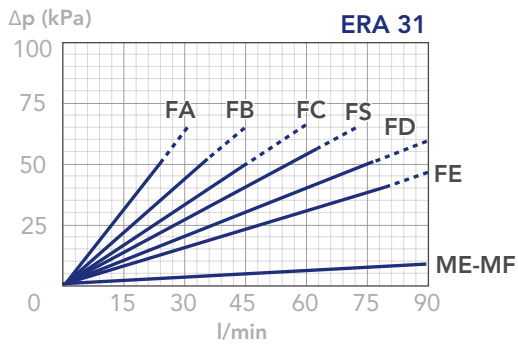

FPH

PRESSURE FILTERS



BYPASS VALVE PRESSURE DROP

When selecting the filter size, these curves must be taken into account if it is foreseen that any flow peak is to be absorbed by the bypass valve, it also must be of proper configuration to avoid pressure peaks. The valve pressure drop is directly proportional to fluid specific gravity.

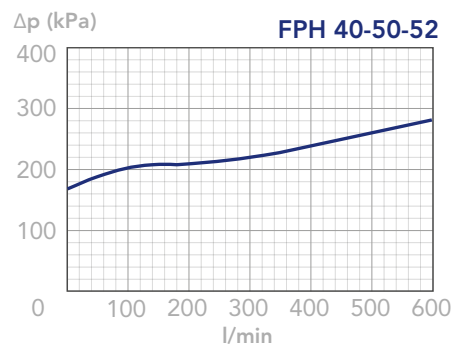
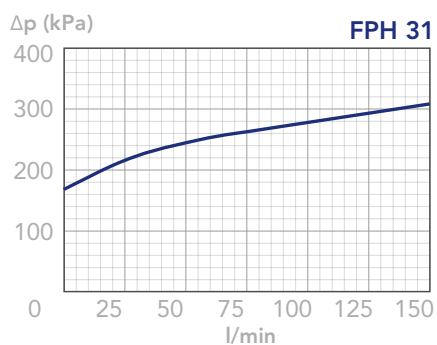

N.B.

All the curves have been obtained with mineral oil having a kinematic viscosity 30 cSt and specific gravity 0,9 kg/dm³; for fluids with different features, please consider the factors described in the first part of this catalogue. All the curves are

obtained from test done at the UFI FILTERS HYDRAULICS Laboratory, according to the specification ISO 3968:2005. In case of discrepancy, please check the contamination level, viscosity and features of the fluid in use.