

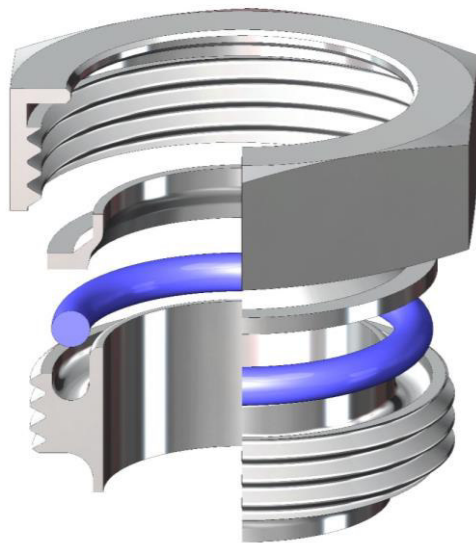

www.PROCESS FITTINGS.COM
Suppliers of Quality Stainless Steel Tubular Components
www.processfittings.com • sales@processfittings.com

HYGIENIC UNIONS

RJT, BS4825-5



www.ProcessFittings.com

V Process Design Ltd, Glenwood, Tollerton Road, Huby, North Yorkshire, YO61 1HT, United Kingdom
[t] 01347 810136 - [m] 07446 899062 - [w] www.processfittings.com - [e] sales@processfittings.com

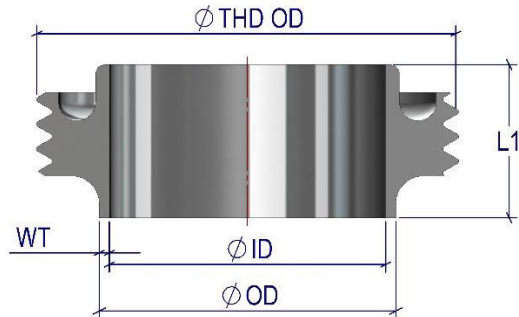

Hygienic Union, RJT, BS4825-5, Male

Size Inch	Dimensions [mm]					Part Code
	OD	ID	WT	THD OD	L1	
1.00"	25.40	22.10	1.65	45.8	27.0	RJT.M.100
1.50"	38.10	34.80	1.65	58.4	27.0	RJT.M.150
2.00"	50.80	47.50	1.65	72.7	27.0	RJT.M.200
2.50"	63.50	60.20	1.65	85.4	27.0	RJT.M.250
3.00"	76.20	72.90	1.65	98.1	27.0	RJT.M.300
4.00"	101.60	97.38	2.11	123.5	27.0	RJT.M.400

Material	Part	Add Code	Product Specifications
316L / 1.4404 Stainless Steel	RJT Male	.6	Certification Available EN10204 3.1
			Suits Tube Standard BS4825-1
			Suits Fittings BS4825-2

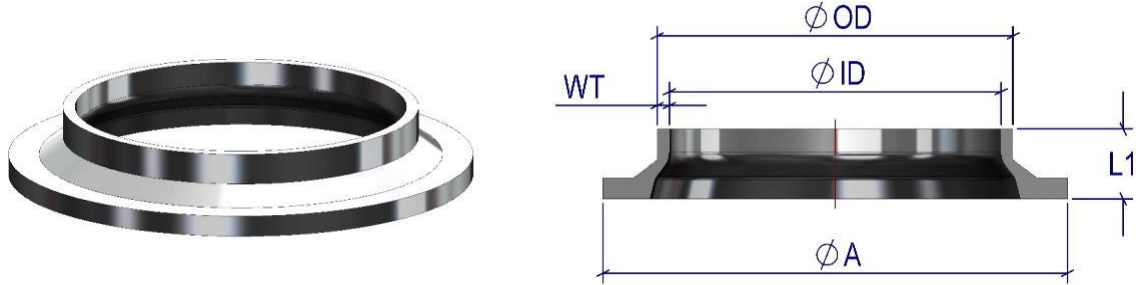

Hygienic Union, RJT, BS4825-5, Weld Liner

Size Inch	Dimensions [mm]					Part Code
	OD	ID	WT	A	L1	
1.00"	25.40	22.10	1.65	41.3	12.7	RJT.L.100
1.50"	38.10	34.80	1.65	54.0	12.7	RJT.L.150
2.00"	50.80	47.50	1.65	66.7	12.7	RJT.L.200
2.50"	63.50	60.20	1.65	79.4	12.7	RJT.L.250
3.00"	76.20	72.90	1.65	92.1	12.7	RJT.L.300
4.00"	101.60	97.38	2.11	117.5	12.7	RJT.L.400

Material	Part	Add Code	Product Specifications
316L / 1.4404 Stainless Steel	RJT Weld Liner	.6	Certification Available EN10204 3.1
			Suits Tube Standard BS4825-1
			Suits Fittings BS4825-2

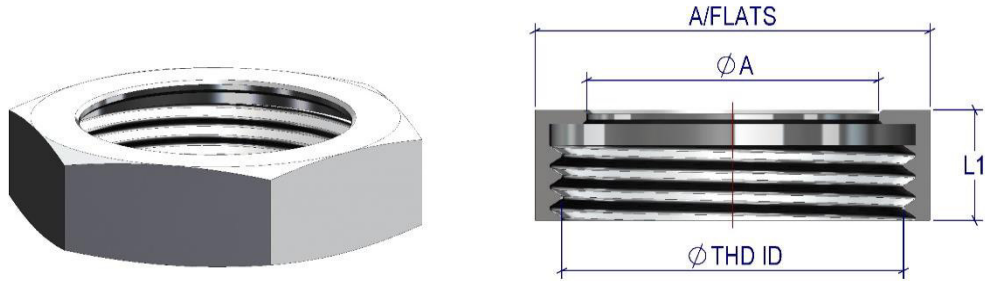

Hygienic Union, RJT, BS4825-5, Nut

Size Inch	Dimensions [mm]					Part Code
	A/FLATS	THD ID	A	L1		
1.00"	50.8	42.7	33.3	22.2		RJT.N.100
1.50"	65.0	55.0	46.0	22.2		RJT.N.150
2.00"	79.4	67.9	58.7	22.2		RJT.N.200
2.50"	92.1	80.6	71.4	22.2		RJT.N.250
3.00"	104.8	93.3	84.1	22.2		RJT.N.300
4.00"	130.2	118.7	109.5	22.2		RJT.N.400

Material	Part	Add Code	Product Specifications	
316L / 1.4404 Stainless Steel	RJT Nut	.6	Certification Available	EN10204 3.1
304L / 1.4401 Stainless Steel	RJT Nut	.4	Suits Tube Standard	BS4825-1
			Suits Fittings	BS4825-2

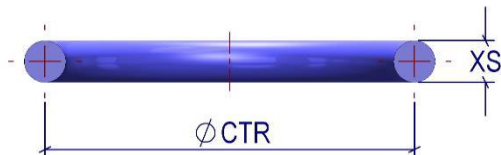

Hygienic Union, RJT, BS4825-5, O-Ring / Seal

Size Inch	Dimensions [mm]				Part Code
	CTR	XS			
1.00"	33.3	6.6			RJT.O.100
1.50"	46.0	6.6			RJT.O.150
2.00"	58.7	6.6			RJT.O.200
2.50"	71.4	6.6			RJT.O.250
3.00"	84.1	6.6			RJT.O.300
4.00"	109.5	6.6			RJT.O.400

Material	Part	Add Code	Product Specifications	
EPDM	O-Ring / Seal	.E	Certification Available	EN10204 3.1
BUNA-N (Nitrile)	O-Ring / Seal	.N	Suits Tube Standard	BS4825-1
Silicone	O-Ring / Seal	.S	Suits Fittings	BS4825-2
VITON	O-Ring / Seal	.V		

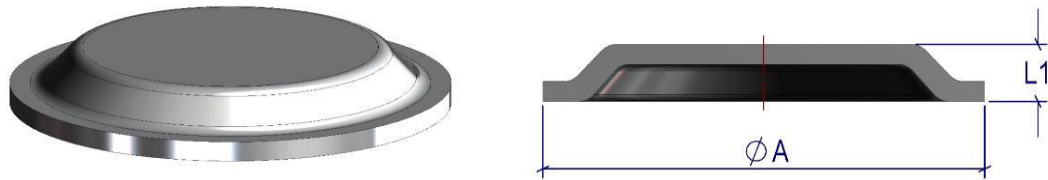

Hygienic Union, RJT, BS4825-5, Blank Cap Liner

Size Inch	Dimensions [mm]				Part Code
	BC OD	L1			
1.00"	41.3	8.7			RJT.BC.100
1.50"	54.0	8.7			RJT.BC.150
2.00"	66.7	8.7			RJT.BC.200
2.50"	79.4	8.7			RJT.BC.250
3.00"	92.1	8.7			RJT.BC.300
4.00"	117.5	8.7			RJT.BC.400

			Product Specifications	
316L / 1.4404 Stainless Steel	RJT Blank Cap	.6	Certification Available	EN10204 3.1
			Suits Tube Standard	BS4825-1
			Suits Fittings	BS4825-2

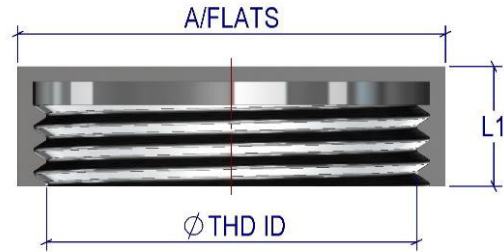
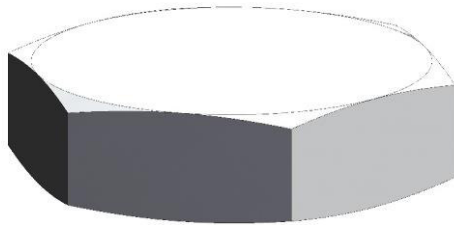

Hygienic Union, RJT, BS4825-5, Blank Nut

Size Inch	Dimensions [mm]				Part Code
	A/FLATS	THD ID		L1	
1.00"	50.8	42.7		22.2	RJT.BN.100
1.50"	65.0	55.0		22.2	RJT.BN.150
2.00"	79.4	67.9		22.2	RJT.BN.200
2.50"	92.1	80.6		22.2	RJT.BN.250
3.00"	104.8	93.3		22.2	RJT.BN.300
4.00"	130.2	118.7		22.2	RJT.BN.400

Material	Part	Add Code	Product Specifications
316L / 1.4404 Stainless Steel	RJT Nut	.6	Certification Available EN10204 3.1
304L / 1.4401 Stainless Steel	RJT Nut	.4	Suits Tube Standard BS4825-1
			Suits Fittings BS4825-2